



User Manual

MPS Series Energy Storage Converter



CONTENTS

1	About This Manual	1
1.1	Preface	1
1.2	Applicable products	1
1.3	Content abstract	1
1.4	Symbols	1
2	Safety Instructions	3
2.1	Personnel Requirements	3
2.2	Safety Warning Operation	3
2.3	Device Identification Protection	3
2.4	Electricity Safety Matters	4
2.5	Environmental Space Requirements	4
2.6	On-line test specification	5
2.7	Touch Screen Parameter Setting	5
2.8	Maintenance Or Overhaul Specifications	5
2.9	Product Scrapping	6
2.10	Other Considerations	6
3	Product introduction	7
3.1	Introduction of energy storage system	7
3.2	Product Appearance	8
3.3	Product Application	9
3.4	Product Features	9
3.5	Communication Solutions	10
3.6	Technical Parmeter Table	11
4	Inverter Mode and Function	12
4.1	Working Mode Introduction	12
4.2	Introduction of Inverter Status	13
5	Mechanical Installation Guidance	15
5.1	Precautions Before Installation	15
5.2	Installation Process	15
5.3	Installation Preparation	16
5.4	Machine Transportation	17
5.5	Location and Fixation	19
5.6	Design And Installation Of Air Ducts	21
6	Electrical Installation Guidance	23

6.1 Cable Requirements	23
6.2 Connection Terminal	24
6.3 Wiring Specification	24
6.4 Fixation and Protection of Connecting Cables	25
6.5 Remove Switch Baffle And Lower Panel	25
6.6 Installation dimension wiring diagram.....	26
6.7 DC Side Wiring.....	26
6.8 AC Side Wiring.....	27
6.9 Communication cable wiring	28
6.10 System Grounding.....	28
6.11 Installation Is Complete	29
7 Test Run.....	30
7.1 Pre-Boot Check.....	30
7.2 Start-Up Operation Flow	31
7.3 Shutdown Operation Flow	34
8 Touch Screen Operational Guidelines	36
8.1 Introduction of Touch Screen	36
8.2 Alarm Buzzer	37
8.3 Communication Settings	37
8.4 Main interfaces introduction	38
8.5 Advanced Settings.....	45
8.6MPS converter program upgrade	46
9 Maintenance and troubleshooting.....	47
9.1 Explain	47
9.2 Matters Needing Attention	47
9.3 Fault Handling	49
Appendix I: Quality Assurance.....	56

1

About This Manual

1.1 Preface

Dear Customer:

Thank you for using the MPS Series Inverter. We sincerely hope that our product can meet your needs. We also invite you to put forward more valuable suggestions on the product performance and function.

1.2 Applicable products

This manual is applicable to the product types as follows:

Type	AC Rated Power	Split model	Integrated model
MPS0030	30kW		√
MPS0050	50kW		√
MPS0100	100kW		√
MPS0150	150kW		√
MPS0250	250kW	√	
MPS0500	500kW	√	

1.3 Content abstract

- ◆ For users, the manual details the product information, installation instructions, operation, maintenance and troubleshooting. Before installing and debugging or running any equipment, the user must read and understand all the instructions contained in this manual and be familiar with the relevant safety symbols.
- ◆ Readers need to have a certain degree of electrical theory, electrical wiring and professional mechanical knowledge. Before installing this product, please read this manual carefully and ensure that the relevant personnel can easily access and use it.
- ◆ The contents, pictures, logos, symbols, etc. used in this manual are owned by the company. Non-company personnel are not allowed to publicly reproduce all or part of the content without written authorization.

1.4 Symbols

In order to ensure the safety of the user's personal and property when using the product, and to better use the product, the manual provides relevant information and highlights it with appropriate symbols.

The following list of symbolic hints may be used in this manual, please read them carefully.

⚠ DANGER

"Danger" indicates that there is a high potential hazard which, if not avoided, will result in death or serious injury.

⚠ WARNING

"Warning" indicates that there is a moderate potential hazard which, if not avoided, may result in death or serious injury.

⚠ CAUTION

"Caution" indicates that there is a low potential hazard which, if not avoided, may result in moderate or minor injury.



NOTE

"Note" indicates that there is a potential risk which, if not avoided, may result in abnormal operation of the equipment or property damage.



"Instruction" is the additional information in the manual to emphasize or supplement the content. It may also provide tips or tricks for optimized use of the product, which can help you solve one problem or save your time.

Please pay attention to the warning labels on the product, which include:

Label	Meaning
	This label indicates there is high voltage within the product, and touch may cause an electric shock.
	This symbol indicates that the temperature here is higher than the acceptable range of the human body, and do not contact in order to avoid personal injury.
	This symbol indicates here is the protective grounding (PE) terminal, and solid grounding is needed to ensure operators' safety.

2

Safety Instructions

2.1 Personnel Requirements

- ◆ Only professional electricians or qualified personnel can operate the product.
- ◆ Operators should be fully familiar with the structure and working principle of the whole energy storage system.
- ◆ Operators should be fully familiar with this manual "MPS Series Energy Storage Inverter User Manual"
- ◆ Operators should be fully familiar with the relevant standards in the country/area where the project is located.



WARNING

- It is strictly forbidden to maintain or overhaul the equipment when it is live!
- At least **two persons** must be ensured to be present during maintenance or overhaul of the equipment. The equipment has been disconnected safely and waited for 15 minutes until the inverter discharge is completed before the maintenance or maintenance operation can be carried out.

2.2 Safety Warning Operation

When installing, routine maintenance and overhaul of energy storage inverter, it is necessary to avoid incorrect operation or accidents when personnel are close to each other. Please observe the following:

- ◆ In order to prevent mis-closing of the switch, a clear mark should be set up at the front and rear switches of the energy storage inverter.
- ◆ Set up warning signs or safety cordons near the operation area.
- ◆ After the completion of maintenance or overhaul, be sure to pull out the key of the cabinet door and keep it stored safely.

2.3 Device Identification Protection

- ◆ The warning signs on the device and cabinet of the energy storage inverter contain important information for safe operation of the energy storage inverter. Removal or damage is strictly prohibited!
- ◆ A nameplate is installed inside the front door of the energy storage inverter. The nameplate contains important parameter information related to the product. Removal or damage is strictly prohibited!





CAUTION

- Make sure the device logo is clear and readable at all times.
- Once the device logo is damaged or blurred, it must be replaced immediately.

2.4 Electricity Safety Matters

2.4.1 Electrical safety

 DANGER	<p>There is a lethal high voltage inside the product!!</p> <ul style="list-style-type: none">● Do not touch terminals or conductors connected to power network circuits.● Attention should be paid to all instructions or safety instructions for connection to the power grid and to the warning signs on the products.● Observe the safety precautions listed in this manual and other relevant documents of the equipment.
--	---

 DANGER	<p>Damaged equipment or system failure may cause electric shock or fire!!</p> <ul style="list-style-type: none">● Preliminary visual inspection before operation to check whether the equipment is damaged or there are other dangers.● Check the safety of other external equipment or circuit connections.● Confirm that the equipment is in a safe state before it can be operated.
--	--

2.4.2 Electrostatic Protection

 CAUTION	<p>Electrostatic sensors on PCB or elsewhere can be damaged by improper operation or contact of operators.</p> <ul style="list-style-type: none">● Operators are advised to avoid unnecessary circuit board contact.● Operators should abide by the electrostatic protection rules, such as wearing anti-static hand rings.
---	--

2.4.3 Notes for Energy Storage Batteries

 DANGER	<ul style="list-style-type: none">● There is a fatal high voltage between the positive and negative electrodes of the energy storage battery pack connected with the energy storage inverter.● When maintaining the equipment, ensure that the connection between the energy storage inverter and the energy storage battery pack is completely disconnected.
--	--

2.5 Environmental Space Requirements

2.5.1 Escape Channel Requirements

In order to ensure that staff members can evacuate the scene promptly in case of accidents, please observe the following items:

- ◆ Do not place flammable and explosive materials around the inverter.
- ◆ It is strictly forbidden to pile up debris in the escape route or occupy the escape route in any form.

2.5.2 Moisture Protection

Do not use the inverter in excess of the specified humid environments listed!

 CAUTION	<p>Damage to the energy storage inverter is very likely in humid environment!!</p> <p>In order to ensure the normal use of various functions of energy storage inverter, please observe the following items: :</p> <ul style="list-style-type: none">● Do not open the cabinet door when the air humidity is over 90%.● Avoid opening the cabinet door in rainy or wet weather to maintain or repair the energy storage inverter.
---	--

2.6 On-line test specification

2.6.1 On-line Test

 DANGER	<p>There is a high voltage in the equipment. Accidental contact may lead to fatal shock hazard. Therefore, in live measurement, it should::</p> <ul style="list-style-type: none">● Ensure adequate levels of protection (such as wearing insulating gloves, insulating shoes, etc.).● At least two persons must be ensured to be on site to ensure personal safety.
--	---

2.6.2 Use of Measuring Equipment

In order to ensure that the electrical parameters meet the requirements, it is necessary to use relevant electrical measuring equipment when conducting electrical connection and trial operation of energy storage inverter.

 WARNING	<ul style="list-style-type: none">● Selection of measuring range, usable conditions and other high-quality measuring equipment that meet the requirements of the site.● Ensure that the connection and use of measuring equipment are correct and standardized so as to avoid the danger of arcing.
---	--

2.7 Touch Screen Parameter Setting

The parameters of touch screen are closely related to the operation of energy storage inverter. These parameters can only be modified after reliable analysis and evaluation of the operation status of the system and energy storage inverter.

 WARNING	<ul style="list-style-type: none">● Using inappropriate parameter settings may affect the normal function and capabilities of energy the storage inverter.● Only authorized professionals can set the parameters of energy storage inverters.
---	--

2.8 Maintenance Or Overhaul Specifications

The following points should be noted when performing maintenance or maintenance operations on equipment: :

- ◆ Securely mark and ensure that the energy storage inverter will not be accidentally re-energized.
- ◆ Use a multimeter to ensure that the internal discharge of the energy storage inverter is completed.
- ◆ Ensure that the equipment is well grounded.
- ◆ Any live parts must be covered with insulating materials.
- ◆ After the energy storage inverter is switched off and the AC/DC power supply is disconnected, the front door can be opened after at least 15 minutes to maintain or repair the energy storage inverter.
- ◆ During the whole process of maintenance and overhaul, it is necessary to ensure adequate escape route or space.

2.9 Product Scrapping

- ◆ When the energy storage inverter needs to be discarded, it can not be treated as conventional waste, we will accept this product as per W and there may be a handling fee.
- ◆ Alternatively contact the local authorized professional recycling agency.

2.10 Other Considerations

The following protective or emergency measures shall be taken according to the actual operation summary:

- ◆ When maintaining and repairing the equipment, relevant personnel should take appropriate protective measures according to their needs, such as wearing noise-proof earplugs, insulating shoes and scald-proof gloves.
- ◆ If installation site of energy storage inverter is remote, emergency rescue facilities should be considered in the event of an accident.
- ◆ Use all necessary supplementary measures to ensure the safety of personnel and equipment.



CAUTION

All operations of energy storage inverters must meet the relevant national/regional standards.



All descriptions in this manual are for energy storage inverters with standard configurations. If you have special needs, please give instructions to us. When ordering. Specifically, please refer to the actual products you receive.

This manual does not cover all possible situations during operation, maintenance and overhaul. If you encounter situations that are not explained in the manual, Please contact us

3

Product introduction

3.1 Introduction of energy storage system

Energy Storage System (ESS) is energy storage, which refers to the storage of a form of energy in the same form or converted into another form of energy through a medium or equipment. A cyclic process in which a specific form of energy is released. The energy storage system is an important part of the "generating-transmission-transformation-distribution-utilization" link of the power grid, and an indispensable part of the energy Internet and smart energy.

Power generation side: The energy storage system can participate in the rapid response frequency regulation service, improve the reserve capacity of the power grid, and can provide continuous power supply to end users from renewable energy sources such as wind energy and solar energy. Overcome its volatility, intermittent and other shortcomings;

Transmission and distribution link: The energy storage system can effectively improve the reliability of the transmission system and improve the quality of electric energy;

User side: The distributed energy storage system optimizes electricity consumption under the coordinated control of the smart microgrid energy management system, reduces electricity consumption costs, and maintains the high quality of electricity.

In the ESS, the energy conversion is mainly realized by the power conversion system (PCS for short), as shown in Figure 3-1below:

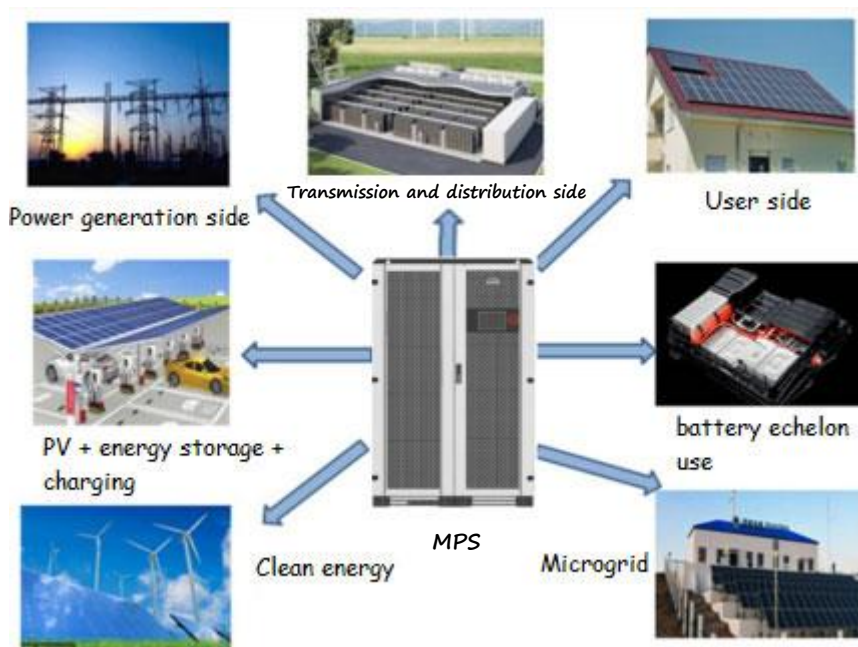

Figure 3-1 Application scenarios of energy storage converters in ESS

3.2 Product Appearance

The appearance and external components of the energy storage inverter are described as follows:



MPS0030
MPS0050

MPS0100
MPS0150



MPS0250





MPS0500



EPO emergency stop button

※: MPS0250 and MPS0500 are split models, MPS0250 consists of a photovoltaic controller and an energy storage inverter, and MPS0500 consists of two photovoltaic controllers and an energy storage inverter.

 <p>WARNING</p>	<p>High Voltage Electricity Danger!</p> <ul style="list-style-type: none"> ● When pressing the emergency shutdown button, the AC/DC connection terminal of the energy storage inverter is still live! ● There is still a fatal high voltage inside the energy storage inverter!
---	---

 <p>WARNING</p>	<p>The emergency shutdown button can be used to turn off the energy storage inverter only in a fault scenario! If the emergency shutdown button is not properly used, it can cause damage to the energy storage inverter. If the emergency shutdown button is pressed in the case of load, the related parts of the energy storage inverter will encounter greater stresses and may fail.</p>
---	---

3.3 Product Application

MPSseries energy storage converters are suitable for mine off-grid, island off-grid, villages and towns without electricity (power shortage), rural off-grid, energy storage converter product application as shown in Figure 3-2 below:

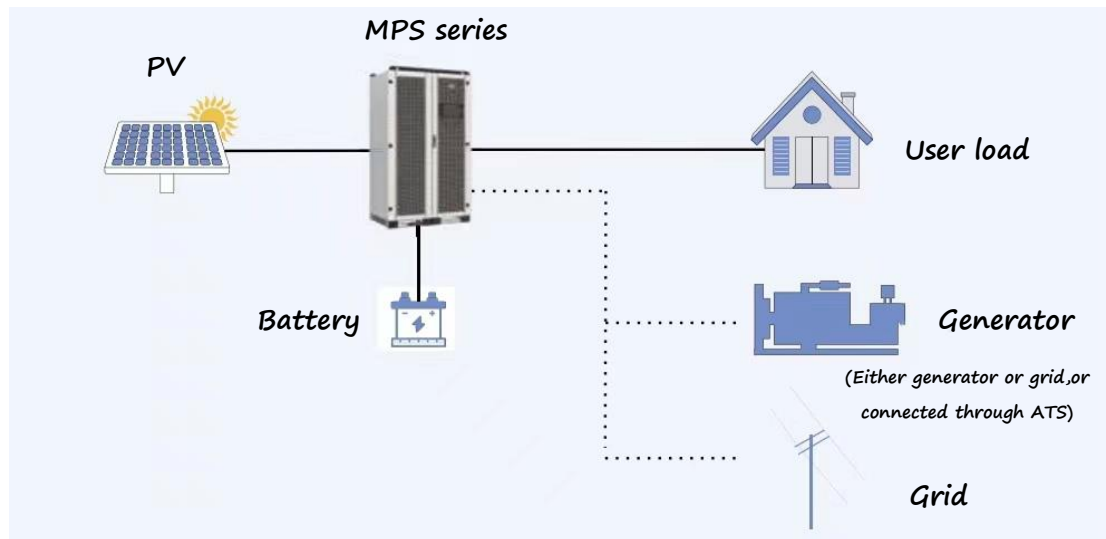

Figure 3-2 Product application

3.4 Product Features

The MPS series energy storage converter adopts advanced digital control technology, which optimizes the control performance and improves the reliability of the system. It is suitable for different battery charging and discharging needs. Its main performance characteristics are as follows: Integrated solution to support simultaneous access of load, battery, grid or diesel generator and photovoltaic.

Supports multiple working modes of spontaneous self-use, battery priority, peak shaving and valley filling.

- ◆ BMS system communication supports RS485, CAN.
- ◆ Can accept EMS dispatch, communication methods include RS485, Ethernet, etc.
- ◆ Integrated EMS function power supply is safe and stable, and the utilization of new energy is maximized.
- ◆ Flexible support for lithium battery and lead-acid battery, battery capacity and discharge time prediction.
- ◆ The photovoltaic controller can be expanded, which is convenient for flexible configuration of photovoltaic capacity.
- ◆ Off-grid belt has strong three-phase unbalanced load capacity.
- ◆ Power frequency design, strong impact resistance.
- ◆ The dual-channel auxiliary power supply mode is adopted, and the redundant design improves reliability.
- ◆ Independent air duct design, excellent heat dissipation design.

3.5 Communication Solutions

3.5.1 BMS Communication scheme

Through CAN/RS485 communication cable, energy storage inverter can communicate with BMS to realize data transmission.

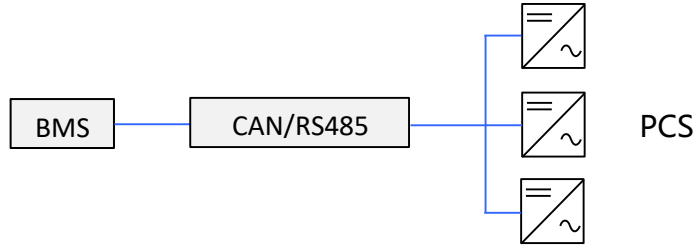

Figure3-3 BMS transmits data through CAN/RS485

3.5.2 EMS Communication scheme

Through Ethernet/RS485 communication line, the energy storage inverter can communicate with EMS, and monitor the energy storage system independently designed. The software can monitor the energy storage inverter in real time .

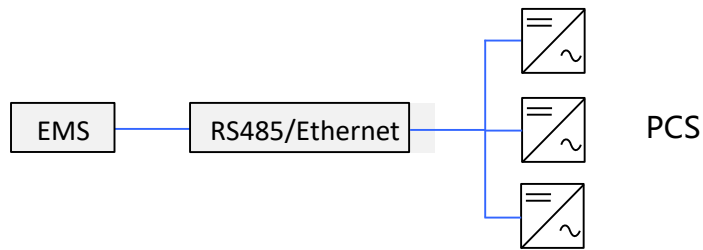

Figure3-4 EMS transmits data through RS485/Ethernet

3.5.3 Communication Scheme of Upper Computer

The energy storage inverter communicates with the host computer through RS485 inverter. Several energy storage inverters are connected through 485 bus, and finally connected to the upper terminal.

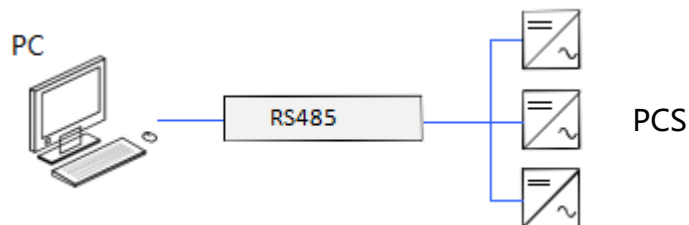

Figure3-5 PC transmits data through RS485 inverter

3.6 Technical Parameter Table

Type	MPS0030	MPS0050	MPS0100	MPS0150	MPS0250	MPS0500
AC (Grid Connection)						
Max output power[kVA]	33kVA	55kVA	110kVA	165kVA	275kVA	550kVA
Rated Power [kW]	30kW	50kW	100kW	150kW	250kW	500kW
Rated Voltage [V]	400V					
Rated Current [A]	43A	72A	144A	216A	361A	722A
Voltage Range[V]	320V-460V					
Rated Frequency [Hz]	50/60Hz					
Frequency Range [Hz]	45-55/55-65Hz					
THDI	<3%					
Power Factor	1.0{0.8 lead-0.8 hysteresis(Settable)}					
AC connection	3W+N+PE					
Transformer ratio	100/400	200/400	270/400	270/400	270/400	315/400
AV (Off Grid)						
Max output power[kVA]	33kVA	55kVA	110kVA	165kVA	275kVA	550kVA
Rated Power [kW]	30kW	50kW	100kW	150kW	250kW	500kW
Rated Voltage [V]	400V					
Rated Current [A]	43A	72A	144A	216A	361A	722A
THDU	< 2% Linear					
Rated Frequency [Hz]	50/60Hz					
Overload Capacity	110% long-term					
Photovoltaic input						
Max.Photovoltaic Input Voltage [V]	1000V					
Max.Photovoltaic Power [kW]	60/120kW		120/180/240kW		300/360kW	600/660/720kW
MPPT voltage range [V]	250V-850V					
MPPT voltage range@full load [V]	450V-850V					
Battery						
Battery Voltage Range [V]	250V-850V	320V-850V	420V-850V	420V-850V	420V-850V	500V-850V
Max. Charging Power[kW]	60/120kW		120/180/240kW		300/360kW	600/660/720kW
System Parameter						
Dimension [W/D/H](mm)	800×800×1900mm		1200×800×2050mm		(600×720×2050) ×1+1200×800×2050 0mm	(600×720×2050) ×2+1600×1050×2050 0mm
Net weight [kg]	621kg	712kg	936kg	1057kg	426kg+1582kg	426kg×2+2665kg
Ambient Temperature [°C]	- 30°C ~ +55°C					
Relative Humidity	0 ~95% non-condensing					
Protection Grade	IP20					
Noise level [dB]	<70dB					
Altitude [m]	5000(>3000 Derating)					
Shutdown self power consumption [W]	<30W					
Cooling Mode	Air Cooling					
Display and Communication						
Display	LCD touch-screen					
BMS Communication interface	RS485/CAN					
Local Communication	RS485, TCP/IP					
Authentication	TUV、CE					
※: Postscript 1: MPS250 is composed of a photovoltaic controller and an energy storage inverter. MPS500 is composed of two photovoltaic controllers and an energy storage converter. 2: Special models need to be customized and developed						

4

Inverter Mode and Function

4.1 Working Mode Introduction

The MPS working mode can be set on the touch screen, and the user can select the working mode according to different needs (for reference) by clicking the "Operation Mode" in the "Menu" → "System" → "DC/AC Parameter Setting" item:

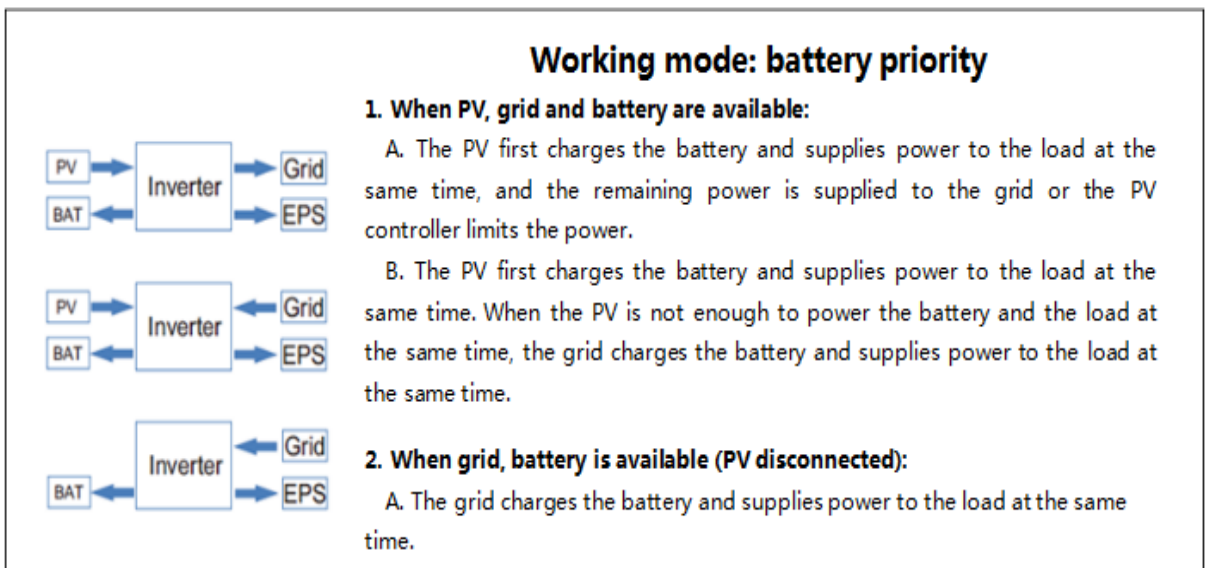
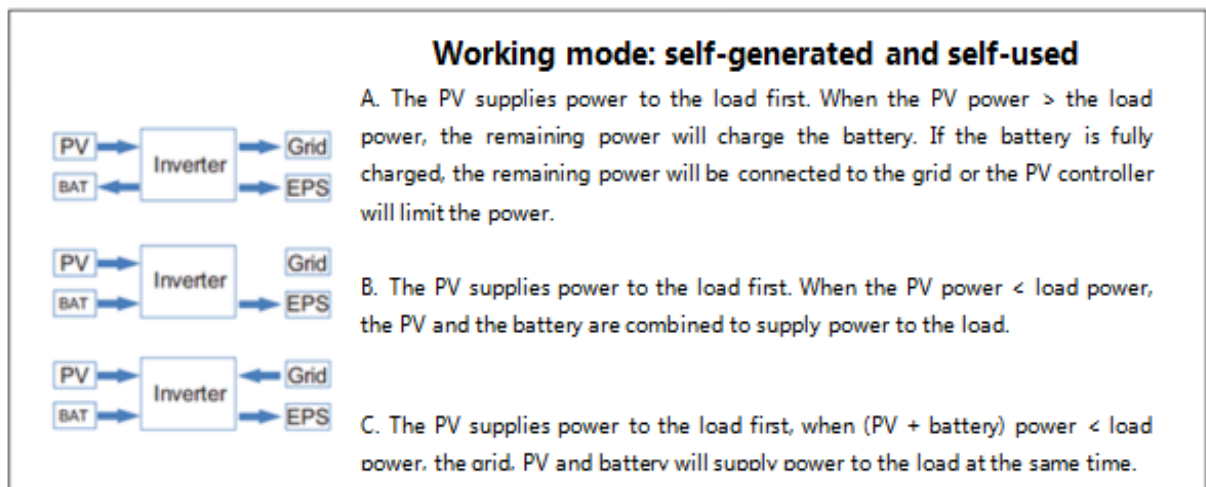

Working mode: peak load shifting

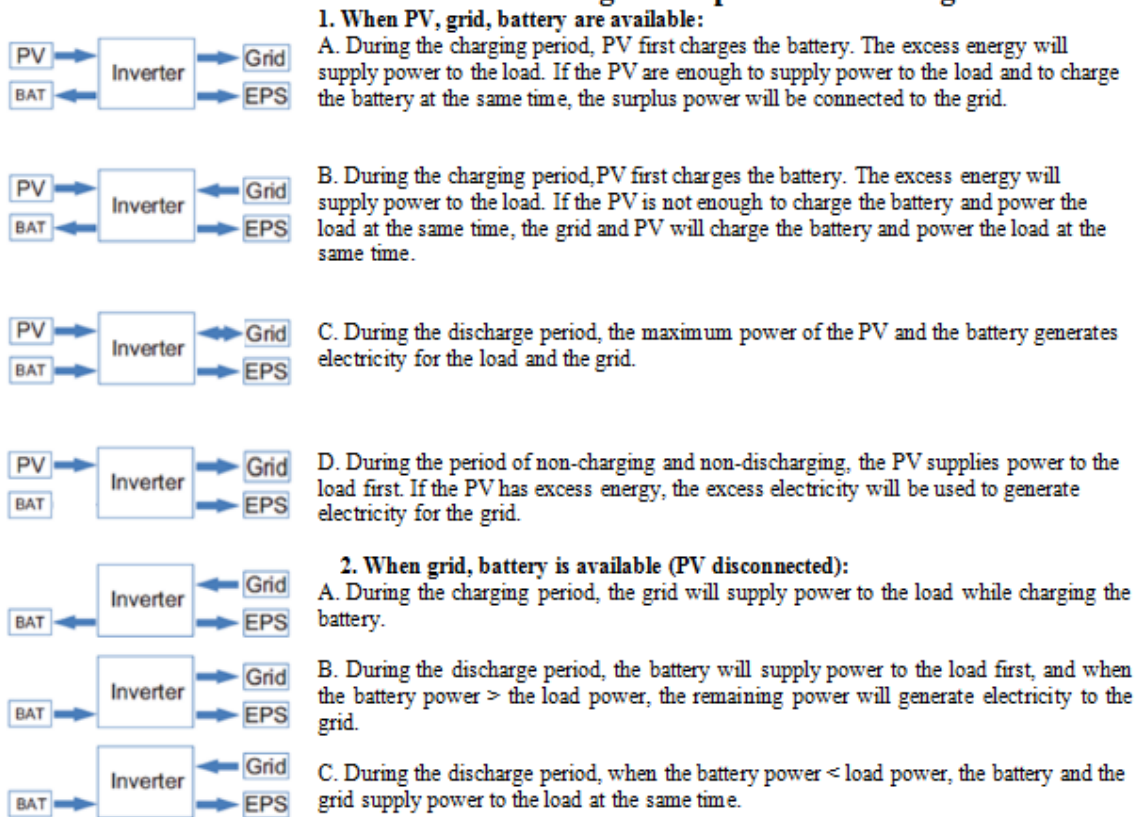

Notice! If the anti-backflow function is set to be enabled, the system will not supply power to the grid once it enters the three working modes of self-generated and self-used, peak load shifting, and battery priority.

4.2 Introduction of Inverter Status

There are six states of energy storage inverter, as shown in Table 4-1 below.

Table 4-1 Status and Description

Status	Description
operation	Normal operation of energy storage inverter.
Standby	When the inverter receives standby instructions from the LCD screen or the host computer, it turns to standby state in shutdown or operation mode. When the AC and DC contactors of the inverter are closed in standby state, the system is in hot standby state. When the LCD screen or the host computer carries out relevant control, the inverter can respond quickly.

Status	Description
fault	When the energy storage system fails, the inverter will stop working, automatically disconnect the contactor on the AC and DC side, and the main circuit will be disconnected from the battery, power grid or load. In the fault state, the system always monitors whether the fault is eliminated or not. If the fault is not eliminated, the system maintains the fault state. If the fault is eliminated, it will enter standby state after the default of 30 seconds.
Shutdown	If the energy storage inverter is in the normal "running" state, the user can stop the energy storage inverter by issuing the stop instruction from the host computer, or Turn off the key through the LCD screen switch page.
Emergency shutdown	In case of failure or emergency, press the emergency shutdown button (EPO) to stop the inverter.
Shutdown	Energy Storage Inverter All Circuit Breakers Disconnect and Switch Reset.



WARNING

When the energy storage inverter fails or the power module fails, it is forbidden to start again through the touch screen.
It should be checked by power off to confirm that there is no problem, and then power on again, otherwise it may damage the inverter.

5

Mechanical Installation Guidance

5.1 Precautions Before Installation

- ◆ Installation of this series of energy storage inverters requires simultaneous operation of at least two qualified personnel, and all electrical installations must conform to local electrical installation standards.
- ◆ When installing, do not touch other parts of the cabinet except the terminal.
- ◆ Safety signs must be set up at all upstream isolators to prevent closing during construction.

5.2 Installation Process

The installation process of MPS series energy storage inverters is as follows:

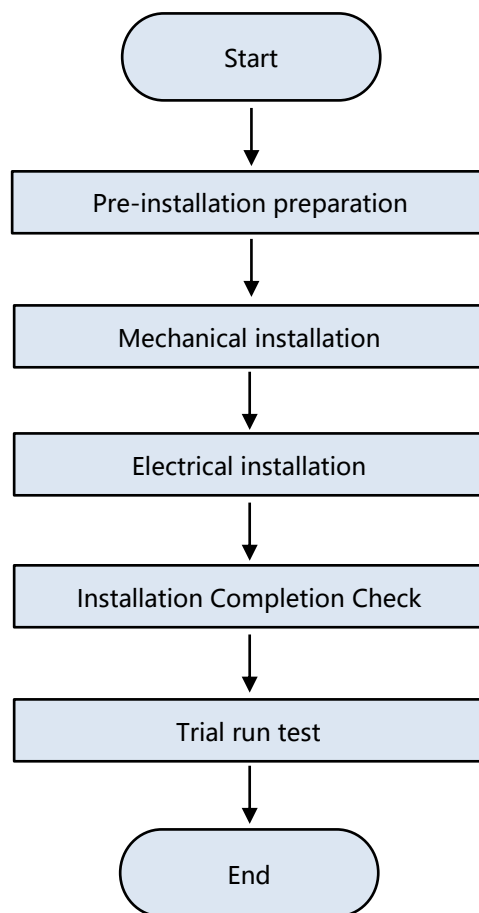

Fig. 5-1 Installation flow chart

5.3 Installation Preparation

5.3.1 Packaging Inspection

Before installation, it is necessary to check whether the equipment is damaged. If any transportation damage is found, please contact the transportation company. and provide photos of the damage.

5.3.2 Delivery Checklist

According to the packing list in the packing box, check whether all the parts delivered are complete or not: transportation

Table 5-1 Delivery list

project	Number
Inverter	1PCS
Key	2PCS
Certificate	1 PCS
Warranty card	1 PCS
Product User Manual	1 PCS
Exit Inspection Report	1 PCS

5.3.3 Installation Tools And Parts

The tools and parts needed to install the inverter are as follows:

Table 5-2 Tool List

Tool	Remarks
Forklift or crane	1 vehicle
Wire stripper	1 pcs
Crimping pliers	1 pcs
Bolt driver	1 pcs
Sleeve	1 pcs
multimeter	1 pcs
Screws, nuts, gaskets	Some

5.3.4 Installation Environment Requirements

Before installing the inverter, please confirm the following requirements:

Table 5-3 Environmental requirements

Project	Requirement
Temperature	-30℃~55℃
Humidity	< 95% (No condensation)
Altitude	<3000m



A place away from electromagnetic radiation sources; a place without oil mist, corrosive gas, flammable gas, etc.; a place where metal powder, dust, oil, water and other foreign objects will not enter the inverter (please do not install the inverter on wood and other flammable substances); places without radioactive substances and flammable substances; places without harmful gases and liquids;

5.4 Machine Transportation



5.4.1 Transport Instructions

- ◆ In order to keep the inverter in a better protective state, packaged transportation should be adopted as far as possible.
- ◆ When using forklift or crane for transportation, attention should be paid to the weight of inverter to ensure that transport equipment has sufficient carrying capacity, and reasonable arrangement of support or lifting points.
- ◆ Inverter packaging is marked with detailed product parameters and transport requirements. Please transport according to the indication of various labels on the packaging. The graphic description of inverter packaging labels is shown in tables 5-4 and 5-5.

Table 5-4 Description of Packing Parameters

Name	Explain
MODEL	Inverter Model
SIZE	Outer packing dimensions
NW	Net weight of inverter
GW	Gross Weight, Inverter Containing Outer Packaging Box

Table 5-5 Graphical description of packing marks

Sign	Describe
	Front-up, no transverse, tilt or inversion of inverter
	Care should be taken to avoid damage to inverter caused by excessive collision and friction in transportation environment.
	Pay attention to damp-proof, avoid the inverter being rained or damped

5.4.2 Forklift Transportation

The following is a sketch of using forklift trucks to transport with or without packaging.

- ◆ When transporting without packing, be sure to unload the fender for transporting.
- ◆ In the course of transportation, the center of gravity of the box device should fall between the two forks of the forklift truck.
- ◆ Forklift trucks are forbidden to carry long distances or take sloping roads.
- ◆ Take-off and landing should be handled lightly to avoid impact or vibration.
- ◆ When transporting, the larger size of the inverter may block the operator's sight. Please arrange the assistant personnel.

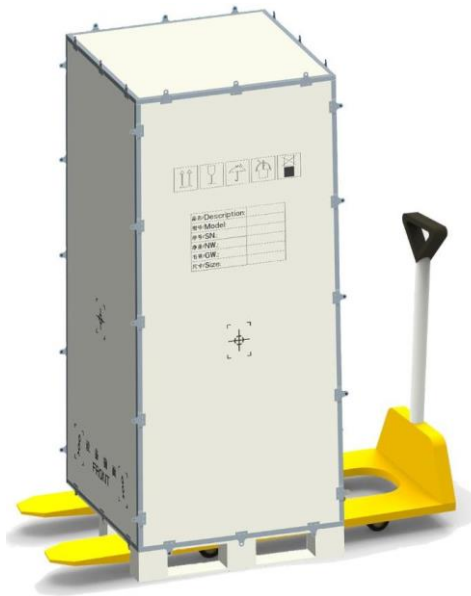

Figure 5-2 Packaged Handling



Figure 5-3 Shipping without packaging

Note: For transportation without packaging, the bottom frame needs to be removed before it can be transported by a forklift!

5.5 Location and Fixation

5.5.1 Space Requirement

- ◆ Installed indoors with good ventilation. Not in high humidity and high ambient temperature, no corrosive gas.
- ◆ Avoid direct sunlight or rain.
- ◆ Ensure that the grounding resistance of the grounding wire in the distribution room is less than 4 in dry environment.
- ◆ Inverter can only be installed on concrete base or other non-flammable mounting surface, and sufficient load bearing should be guaranteed.
- ◆ Avoid placing together with inflammable and explosive materials, meeting fire protection requirements.

The volumetric space reserved size is shown in the following figure:

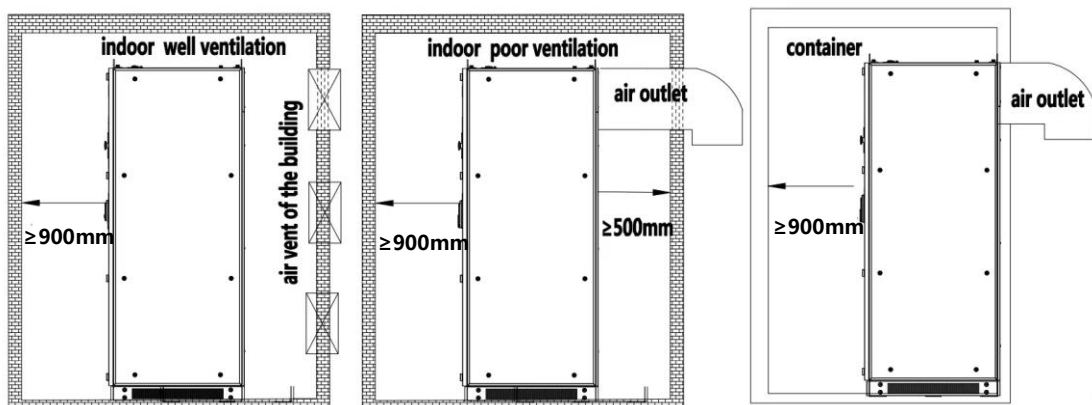

Fig. 5-4 Installation space requirements

5.5.2 Dimensions of Various Models

The mechanical dimensions of each type of MPS series inverter are shown in Table 5-6 below. Users can design and install according to this data.

Table 5-6 Dimensions of MPS Series

Model	Size (W×D×H)
MPS0030	800×800×1900(mm)
MPS0050	800×800×1900(mm)
MPS0100	1200×800×2050(mm)
MPS0150	1200×800×2050(mm)
MPS0250	(600×720×2050) ×1+1200×800×2050mm
MPS0500	(600×720×2050) ×1+1200×800×2050mm

※: MPS0250 and MPS0500 are split models, MPS0250 consists of a photovoltaic controller (600×720×2050) and an energy storage inverter (1200×800×2050), MPS0500 consists of two photovoltaic controllers (600×720×2050) and an energy storage inverter (1200×800×2050).

5.5.3 Base Mounting

The bottom of this series inverters should be connected with the base reliably. The bottom of the inverter has a fixed hole for fixing the inverter on the bottom support channel steel or on the ground. As shown in the following figure:

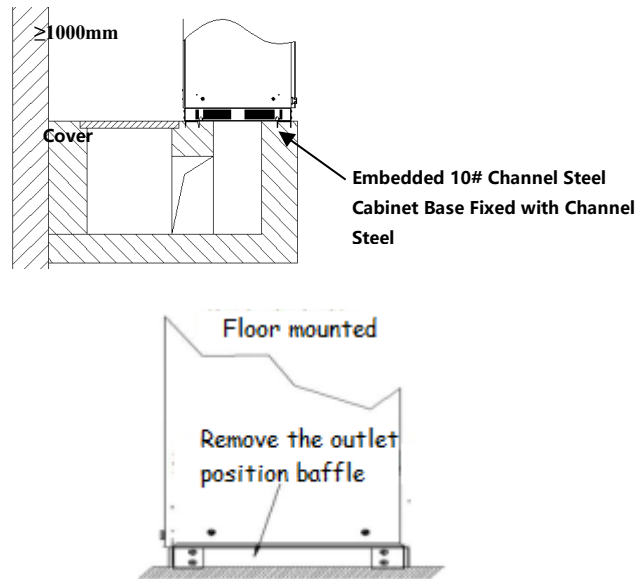

Fig. 5-5 Base mounting and fixing

In the manufacture of channel anchors, it is necessary to design the positioning hole with the base at the bottom of the inverter. The bottom section of each model is shown in the following figures (mm). Cooling air can enter from the front and bottom, and cables from the bottom. In front of the inverter, there are DC and AC inlet and outlet holes.

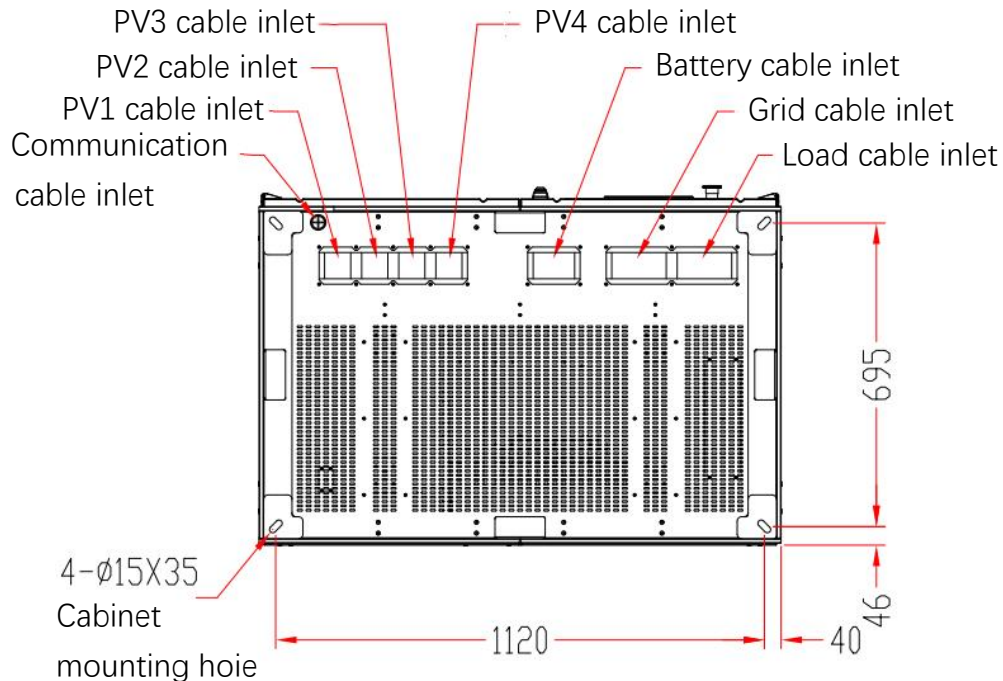

Figure 5-6 Bottom section

※:This bottom section drawing size is only applicable mps0100/150 models.

5.6 Design And Installation Of Air Ducts

5.6.1 Forced Air Cooling System

This series energy storage inverters use forced air cooling for heat dissipation, and need to maintain adequate air intake.

Table 5-6

Type	Min. area of customer shutters for air intake (m ²)
MPS0030/50	0.543858
MPS0100/150	0.6251342
MPS0250	0.7964004
MPS0500	1.2580896
PMDE0150	0.1979004
PMDE0300	0.3594072

5.6.2 Ventilation Environment

In order to meet the ventilation requirements of this series inverters, the installation environment should meet the following requirements:

- ◆ Inverter should avoid installing in the situation of poor ventilation condition and low air flow. It can get more ventilation by increasing construction measures such as air supply grille or fan.
- ◆ Sufficient air intake should be provided at the intake port.
- ◆ Air quality must be guaranteed. If the content of suspended solids such as sand and dust in the air is too high, the air quality can meet the requirements through construction measures (such as installing filters at the air supply grille of the building).

5.6.3 Air Duct Setting

In order to ensure pressure balance, an additional fan can be added at the outlet of the outlet pipe to exhaust the air. The size of ventilation duct should be designed by professionals according to the size of air output. When designing and installing, it is necessary to prevent the phenomenon of backfilling air in the inverter cabinets.

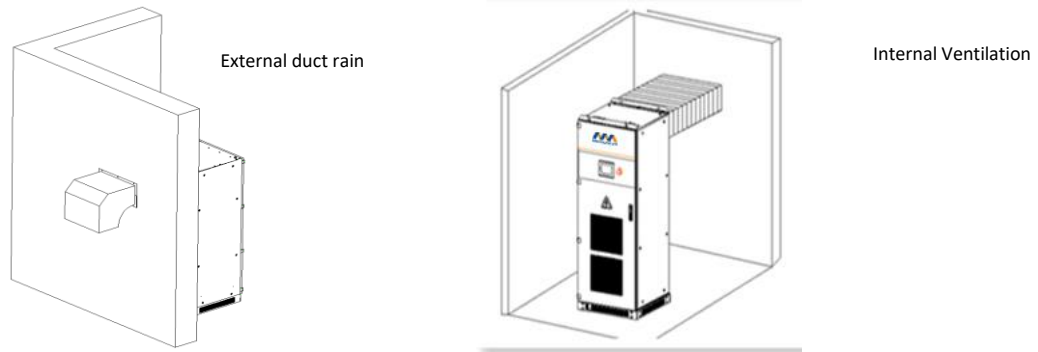

Figure 5-7 Schematic diagram of inverter external duct

※: The specific air duct design should be reasonably designed according to different models combined with the site environment.

Specific requirements for adding air ducts to inverters are as follows:

- ◆ Requirements do not reduce cabinet ventilation by adding ducts
- ◆ The interface between air duct and inverter cabinet is well sealed.
- ◆ The outlet of the duct should be inclined downward (rainproof)
- ◆ Protection should be added to the outlet of the air duct (rodent and bird control, etc.)

The air required by the inverter is inhaled through the bottom vent and the dust net of the front door. Hot air is discharged through the top vent of the inverter, and there is an outlet at the top.

6

Electrical Installation Guidance

6.1 Cable Requirements

According to the capacity allocation requirement of single MPS series inverter, it is suggested that the current passing through 1mm^2 conductor should be no more than 3A, and the same size and type of conductor should be selected for the connection on the same side. The reference requirements for various types of interface cables are given by us. Users can design relevant cables according to the table below. Cables shall be designed in accordance with the instructions in this section and local wiring regulations, taking into account environmental conditions.

Table 6-1 Specifications of power cables for the inverters

Type capacity	Type capacity	Zero line	Ground wire	Positive and negative DC input (per pole)	PV
30KW	$\geq 25\text{mm}^2 \times 3$	$\geq 25\text{mm}^2$	$\geq 16\text{mm}^2$	input 50mm^2	$50\text{mm}^2/\text{group}$
50KW	$\geq 35\text{mm}^2 \times 3$	$\geq 35\text{mm}^2$	$\geq 16\text{mm}^2$	input 70mm^2	$50\text{mm}^2/\text{group}$
100KW	$\geq 50\text{mm}^2 \times 3$	$\geq 50\text{mm}^2$	$\geq 25\text{mm}^2$	input 95mm^2	$50\text{mm}^2/\text{group}$
150KW	$\geq 95\text{mm}^2 \times 3$	$\geq 50\text{mm}^2$	$\geq 50\text{mm}^2$	input 95mm^2	$50\text{mm}^2/\text{group}$
250KW	$\geq 120\text{mm}^2 \times 3$	$\geq 120\text{mm}^2$	$\geq 50\text{mm}^2$	2-way input 120mm^2	$50\text{mm}^2/\text{group}$
500KW	$\geq 185\text{mm}^2 \times 3$	$\geq 185\text{mm}^2$	$\geq 95\text{mm}^2$	4-way input 120mm^2	$50\text{mm}^2/\text{group}$



WARNING

Before wiring operation, confirm that both the municipal power input and BAT input switches are disconnected, and affix warning signs to prevent others from operating the switches.





WARNING

Power cables need trenches or metal trenches to avoid mechanical damage.
Or cause radio frequency interference to peripheral equipment.



The cable dimensions provided in this table are for reference only. The actual selection should be based on the working environment temperature, laying method, heat dissipation conditions and so on.

 CAUTION	The equipment does not have external cables. The above cable recommendation table is not provided by inverters. Users are requested to provide their own cables according to relevant needs.
---	--

 CAUTION	All external cables are connected to the corresponding position after entering the equipment through the bottom entry and exit holes. The terminals and fixing screw used in power cable wiring of this series inverters have been installed at the corresponding wiring terminals when the equipment is delivered.
---	--

6.2 Connection Terminal

Installation indication of terminal and fixed screw used in power cable wiring of inverter:

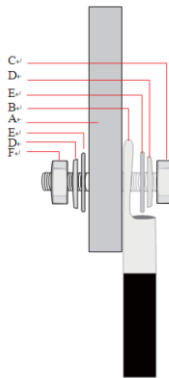

Figure 6-1 Terminal

Table 6-2 Names of wiring terminals

Serial number	Name
A	Copper bar
B	Connection terminal
C	screw
D	Spring washer
E	Large pad
F	Nut

6.3 Wiring Specification

When laying cables, communication lines and power lines should be laid separately. DC and AC circuits need to be laid separately, and the distance between different cables should be more than 300 mm. When the control cable must pass through the power cable, the angle between the two cables should be kept as high as 90 degrees.

The recommended minimum space distance between parallel shielded data lines and power cables corresponds to the field.

Table 6-3 Distance between signal lines and power cables

Parallel Line Length (m)	Minimum Spatial Distance (m)
200	0.3
300	0.5
500	1.2

※The data line should be as close as possible to the supporting line of the surface ring, such as supporting beams, steel troughs, metal guideways, etc.

6.4 Fixation and Protection of Connecting Cables

6.4.1 Cable Fixation

In order to prevent loosening of the copper nose, causing poor contact, or increasing contact resistance leading to fever or even fire, it is necessary to ensure that the screw fastening the terminal meets the torque requirements listed in Table 6-4:

Table 6-4 Screw dimensions and required torques

Screw size	M4	M5	M6	M8	M10	M12	M14	M16
Torque (N.m)	2	3.2	7	16	34	46	58	68

6.4.2 Cable Protection

The protection of cables includes communication cables and power cables. The protective methods are as follows:

Protection of communication cable: Because communication cable is thin, it is easy to break or fall off from the terminal during construction. Therefore, it is suggested that the power circuit should be connected first, and then the connection should be made. When connecting, the cable should be grooved as far as possible. Where there is no groove, the cable should be fastened with tie-in belt. When traveling, the development of thermal elements and strong electric field circuit cables should be avoided.

Protection of power cables: Therefore, the scratch and breakage of cable insulation skin should be avoided when installing connection, because this may lead to short circuit. Power cables must also be properly fixed.

6.5 Remove Switch Baffle And Lower Panel

6.5.1 Remove Baffle

With a screwdriver, loosen the four screws of the lower baffle of the switch, remove the screw and the lower baffle of the switch, and the wiring operation can be carried out. Open the front door as shown in Figure 6-2.

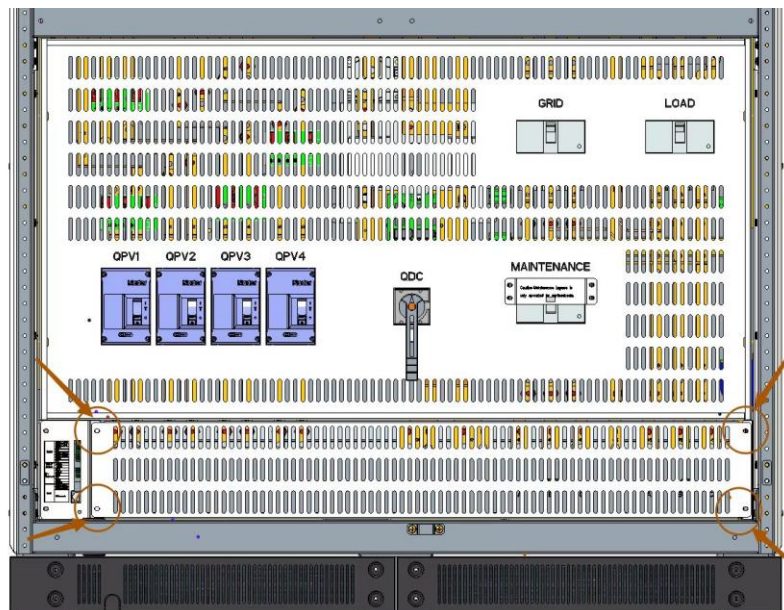

Figure 6-2 Switch baffle

6.5.2 Installation Of Lower Fender

MPS series inverters have lower fencing boards at the bottom of front, back, left and right. They are packaged and placed at the bottom of the packaging box. Before installation, all lower fencing boards of the inverter must be removed and put out. After the inverter is positioned and the screw is locked, the lower fencing boards shall be installed. Dust-proof cotton is installed in the lower fencing board, which can not be lost during installation.

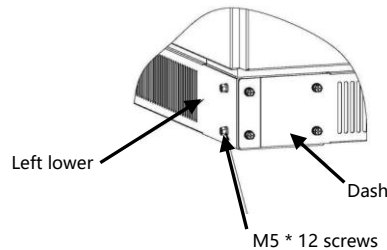

Figure 6-3 Installation of lower fender

6.6 Installation dimension wiring diagram

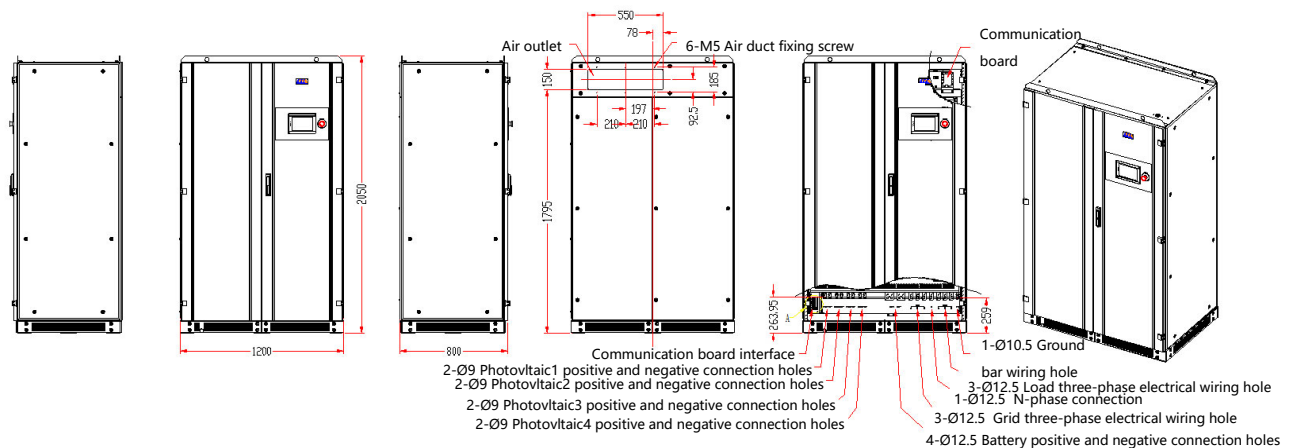



Table 6-4 MPS0100 type

MPS series converters are in and out of line mode, the power terminal can be seen after the switch baffle is removed, available in three screw sizes M8/M10/M12, the internal wiring terminals are shown in diagram 6-4.

6.7 DC Side Wiring

- Step 1:** Verify that all terminals of the inverter have been powered off with a multimeter.
- Step 2:** Identify the positive and negative poles of the cable and mark them well.
- Step 3:** Connect the positive and negative poles of the battery pack to the "BAT+" and "BAT-" terminals. Connect the positive and negative poles of the PV to "PV+" and "PV-" terminals.



DANGER

In order to avoid personal and equipment injury, wiring must be carried out without electricity.

- DC switch is off.
- Multimeter is used to measure that the DC side wiring row is not live.



WARNING

DC input voltage limit. Confirm that the DC input voltage should not exceed 850VDC!

- Any DC input voltage exceeding this limit may cause damage to the inverter.
- Damage and loss of equipment caused in this case do not fall within the scope of quality assurance.



Fixed screw and other parts used for wiring have been installed at the corresponding wiring terminals when the equipment is delivered.
Need to check the material of the external terminal connection point. If copper and aluminium materials are interconnected, special copper and aluminium connectors should be used. Do not connect directly!

6.8 AC Side Wiring

6.8.1 AC Connection

All models of this series energy storage inverters have grid connection. Only those with bypass need to consider bypass connection. Their corresponding relations are shown in the table below. Refer to Section 6.5 and 6.6 for the access location of copper bars.

Table 6-5 Corresponding

A1	Phase A or U connected to power grid
B1	Phase B or V connected to power grid
C1	Phase C or W connected to power grid
N	Phase N Connecting to power grid

Table 6-6 Load connection

A2	Phase A connected to load
B2	Phase B connected to load
C2	Phase C connected to load

6.8.2 AC Side Line Steps:

Step 1: Measure with a multimeter to confirm that all terminals have been powered off.

Step 2: Confirm the phase sequence of the cables and mark them well. Three-phase AC output cable A,B,C, N should be added yellow, green, red and black insulating bushing respectively in order to distinguish the phase sequence.

Step 3: Connect three phases A, B, and C connected to the grid to the grid according to Table 6-5. Connect the three phases A, B and C connected to the load to the load correctly according to Table 6-6.

6.9 Communication cable wiring

The back of the touch screen has reserved the communication line for the external customer interface. Please connect the communication line to the terminal on the back of the touch screen correctly. The description of the external customer interface communication silk screen is shown in Figure 6-5:

※: The communication line can be fine-tuned according to the technical agreement

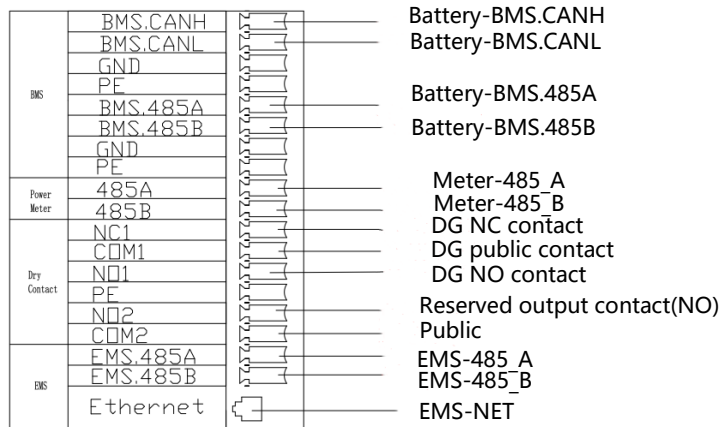

Figure 6-5 Mark Description

6.10 System Grounding

The grounding copper bars in this series energy storage inverters need to be connected reliably by grounding cables. Grounding copper bars have been reliably connected with the outer shell of the inverter in the cabinet. When connecting, it is necessary to connect the grounding copper bars with equipotential connection devices of the installation site or the electrical control room. The resistance shall not be higher than 4Ω , the diameter of grounding cable shall not be less than 16 mm^2 , and the position of the copper bars shall refer to the internal terminal of 6.6 sections.

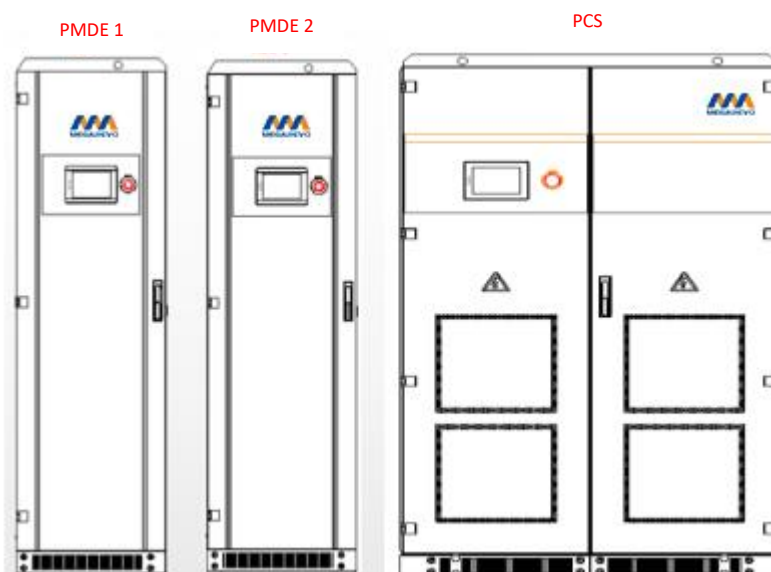

Figure 6-6 MPS0500 split model

When connecting the ground wire of the MPS0500 split model, please connect the ground terminal of PMDE1 to the ground terminal of PCS, and then connect the ground terminal of PMDE2 to the ground terminal of PCS respectively.

※: The ground wire of the split model is connected to the PCS, please do not connect the ground terminal of PMDE1 to the ground terminal of PMDE2.

6.11 Installation Is Complete

After all mechanical and electrical installations have been completed, the removed switch baffles and lower fences need to be reinstalled on the inverter. After installation, power-on operation is allowed only after confirmation is correct.

7

Test Run

7.1 Pre-Boot Check

Before commissioning, a thorough inspection of the installation of the equipment should be carried out, especially to check whether the DC and AC voltages meet the requirements of the inverter, as well as whether the polarity and phase sequence are correct.

Check that all connections have met the requirements of the relevant standards and specifications. And whether the system is well grounded. Grounding resistance is of great importance to the safety of the whole system. It must be determined that the grounding resistance meets the requirements before the first trial operation.



CAUTION

Before commissioning, it is necessary to ensure that all switches on the AC side are open.

Step 1: Check the inverter

The inverter needs to be checked before it is turned on.

- ◆ Check the installation and wiring of the inverter according to Chapters 5 and 6.
- ◆ Ensure that all AC and DC circuit breakers are disconnected.

Step 2: Check AC side voltage

- ◆ Check whether the three phases of the inverter are connected correctly to the three phases of the power grid.
- ◆ Check whether the phase voltage and line voltage are within the predetermined range and record the voltage value.
- ◆ If possible, measure the total harmonic distortion (THD) and view the curve. If the distortion is serious, the inverter may not work.

Step 3: Check DC side voltage

- ◆ The DC side should be connected to the inverter from the battery pack to ensure that the input polarity of each battery pack is correct.
- ◆ The PV side should be connected to the inverter from the PV to ensure that the input polarity of each PV group is correct.



WARNIN

The Battery side voltage shall not exceed 850V.
the PV side- not exceed 1000V.

If the voltage deviation is greater than 3%, it may be caused by load fluctuation, cable damage or cable loosening on site.

Step 4: Check other content

After completing the above check before starting, the following items need to be carefully checked to ensure that they are correct.

- ◆ All links are made in accordance with Chapter 6 of this manual.
- ◆ The protective shield inside the equipment has been firmly installed.
- ◆ The emergency shutdown button is released.
- ◆ The AC side and DC side circuit breakers have been disconnected, i.e. they are in the "OFF" position.
- ◆ The multimeter is used to detect whether the AC and DC side voltages meet the starting conditions of the inverter, and there is no danger of overvoltage.
- ◆ The door of the cabinet has been closed and the key of the cabinet door has been pulled out and handed over to a special person for safekeeping.

**WARNING**

For the long downtime energy storage inverter, before starting, the equipment must be thoroughly and meticulously checked to ensure that all indicators meet the requirements before starting.

7.2 Start-Up Operation Flow

After all of the above are satisfied, the energy storage inverter can be turned on. The operation steps are as follows:

Step 1: Make sure that the DC side and AC side are connected correctly and the DC side voltage is lower than 850V.

Step 2: Close AC and DC circuit breaker switches;

Step 3: Close the lightning protection switch KS (applicable to split models), close KB1, KB2, KB3;

Step 4: After completing the above steps, go through the switch menu on the touch screen, click "DC/DC converter on" until the bottom right of the screen displays from standby to MPPT, click "DC/AC converter on" until the screen displays right below the switch from the converter Turn off the inverter to charge or discharge the inverter. After the machine is turned on normally, you can check the running status of the machine through the touch screen.

Step 5: After the machine is running normally, close the cabinet door and hand over the key to a special person for safekeeping. The detailed startup steps are as follows:

(1) Confirm the photovoltaic input, and close the photovoltaic input switches QPV1 and QPV2 in Figure 7-1. After closing the PV input switch, if the monitor screen was black before, the monitor screen will start running at this time. (When photovoltaic power is transmitted, each photovoltaic channel must be measured to prevent short circuit).

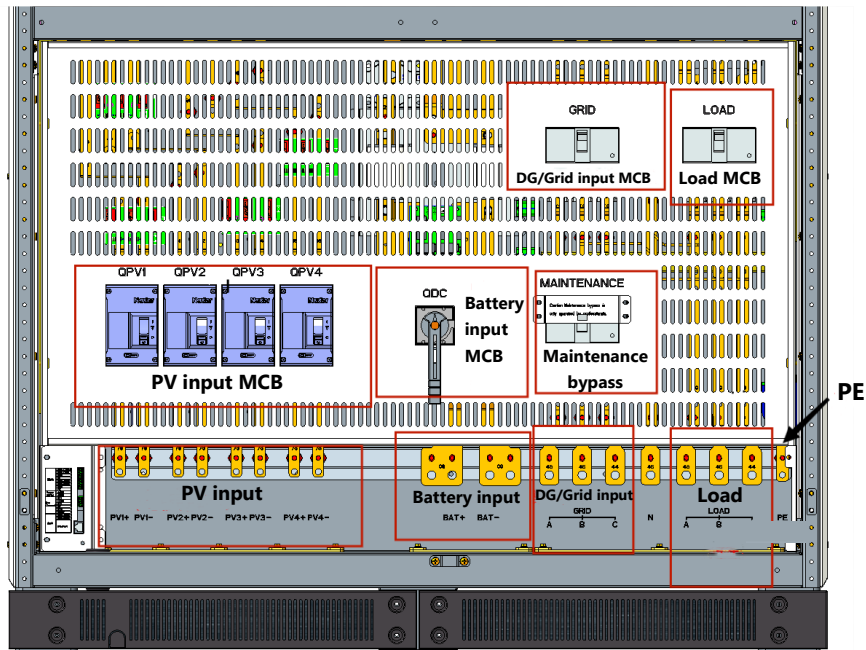

Figure 7-1 MPS input and output figure

(2) The battery system is powered on.

(3) After the photovoltaic input and the battery are turned on, you will hear the sound of the DC contactor closing inside the photovoltaic controller (the closing sound of the DC contactor after the bus is softly lifted), and then the photovoltaic controller displayed in the lower right corner of the monitoring main interface will be heard. The status will change from "off" to "converter x standby".

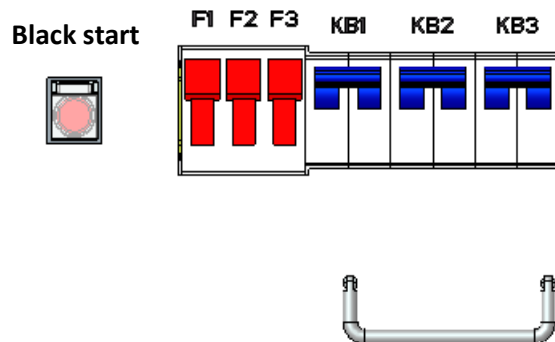

Figure 7-2 Black Start and internal MCB

(4) Open the cabinet door, close KB1, KB2 and KB3, press and hold the "Black Start" red button for 3 seconds as shown in Figure 7-2, wait for about 30 seconds, the battery voltage data will be displayed on the monitoring interface (if the monitoring is running) After the battery voltage data has been displayed, there is no need to press the "Black Start" red button). (If there is power on the AC side, that is, the diesel generator is running or the mains is input, the battery voltage data can be displayed on the monitor without pressing the "Black Start" red button).

(5) Take MPS-500KW as an example, check whether there is a red alarm signal in the upper right corner of the monitor, and it can be turned on if there is no red alarm signal.

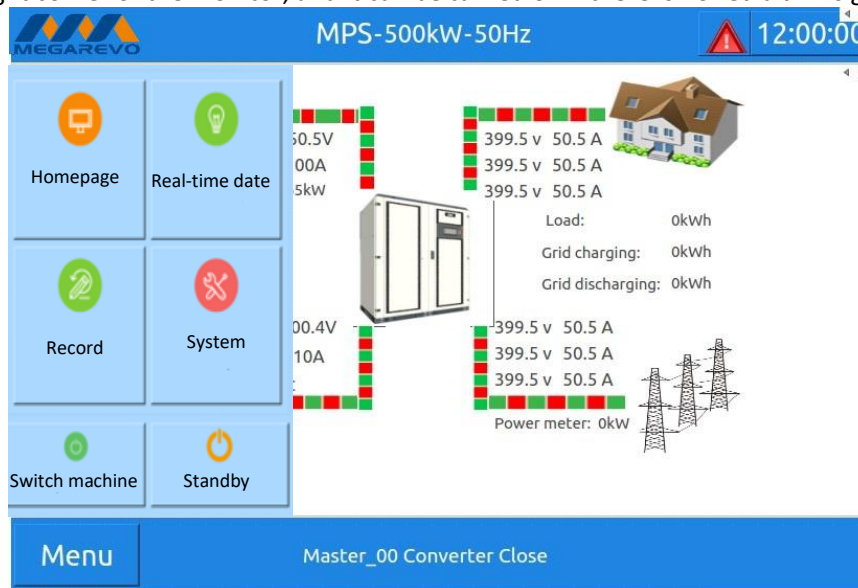

Figure 7-3 Main menu

(6) The photovoltaic controller is turned on. Click "Menu" → "Power On/Off" → "DCDC Converter On" in the lower left corner of the monitor. After clicking "DCDC Converter On", the PV controller status displayed in the lower right corner of the monitoring main interface will change from "Standby" to "Inverter xMPPT", the PV controller is running normally.

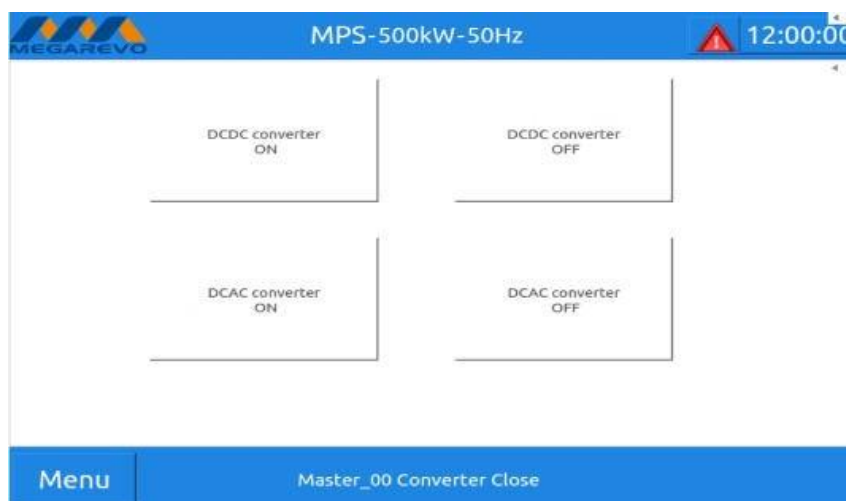

Figure 7-4 Startup and shutdown main interface

(7) The converter is turned on. Click "Menu" → "Switch" → "DCAC Inverter On" in the lower left corner of the monitor (as shown in Figure 7-4). The inverter is soft-started. After the soft-start is completed, the AC contactor pull-in sound will be heard. At this time, the status of the converter displayed in the lower corner of the monitoring main interface will change to "converter off-grid discharge" or "converter off-grid discharge". The inverter is connected to the grid for charging" or "The inverter is connected to the grid to discharge". At this time, the inverter is running normally.

At this point, the startup of the MPS converter is completed.

7.3 Shutdown Operation Flow

7.3.1 Normal shutdown

During normal maintenance or overhaul, shutdown operation should be carried out according to the following procedures:

Step 1: Through the switch menu on the touch screen, click "Inverter Close";

Step 2: When the AC contactor is disconnected and the touch screen shows that after the "inverter" is turned off, the DC side circuit breaker or load switch of the inverter is manually disconnected so that the switch is in the "OFF" position.

Step 3: Disconnect inverter fan switch, auxiliary power switch and lightning protection switch.

Step 4: Disconnect the AC side circuit breaker of the inverter so that the switch is in the "OFF" position.

Step 5: Wait until the bus capacitor discharge is finished, the touch screen is off, and the energy storage inverter is off.



WARNING

When the machine is working normally, it is strictly forbidden to disconnect the circuit breaker directly, so as to avoid dangerous arc damage to the circuit breaker. In severe cases, it may also lead to damage of energy storage inverter.

The detailed steps for shutting down the MPS converter:

(1) Shutdown of the photovoltaic controller. Click "Menu" → "Switch" → "DCDC Converter Off" in the lower left corner of the monitor, click "DCDC" Converter Off", and the PV controller status displayed in the lower right corner of the monitoring main interface will have "Converter xMPPT" " becomes "standby". At this time, the PV controller stops working. (As shown in Figure 7-4 above)

(2) The converter is turned off. Click "Menu" → "Switch" → "DCAC Converter Off" in the lower left corner of the monitor. After clicking "DCAC Converter Off", you will hear the AC contactor disconnecting sound. At this time, the change displayed in the lower corner of the monitoring main interface The converter status will change to "Converter closed". At this point the converter stops working.

7.3.2 Turn off at a time of failure or emergency

In case of emergency or failure, follow the following procedure:

Step 1: Press the emergency shutdown button "EPO";

Step 2: Disconnect the machine DC side circuit breaker or load switch, AC side circuit breaker;

Step 3: Reset the EPO button after confirming that the danger or fault has been removed and needs to be operated.



WARNING

Emergency shutdown button is only used in case of machine failure or emergency. When shutdown is normal, shutdown operation should be carried out through the button shutdown instruction on touch panel.

In case of crisis, press the emergency shutdown button directly to ensure prompt response.

7.3.3 Use of maintenance bypass

The maintenance bypass circuit breaker (MAINTENANCE) in Figure 7-1 is normally in the off state. The maintenance bypass is to ensure that the load is not powered off when the MPS converter is overhauled or faulty (provided that the grid is powered), and the maintenance bypass is closed. After that, connect the diesel generator or grid to the load.

The specific operation steps are:

- (1) Confirm that the diesel generator is in normal operation or the grid has electricity;
- (2) MPS converter shutdown (refer to 7.3.1);
- (3) Disconnect all switches
- (4) Remove the baffle plate on the maintenance bypass circuit breaker
- (5) Close the maintenance bypass circuit breaker;

※: After equipment maintenance or fault recovery, the maintenance bypass must be disconnected, and the maintenance bypass baffle must be replaced.

8

Touch Screen Operational Guidelines

8.1 Introduction of Touch Screen

8.1.1 Operation interface

Taking MPS-500KW as an example, the LCD touch screen is installed on the front of the converter cabinet door. Users can monitor the converter through the LCD screen, read the data of the converter, and set the parameters of the converter. The touch screen interface is as shown below:

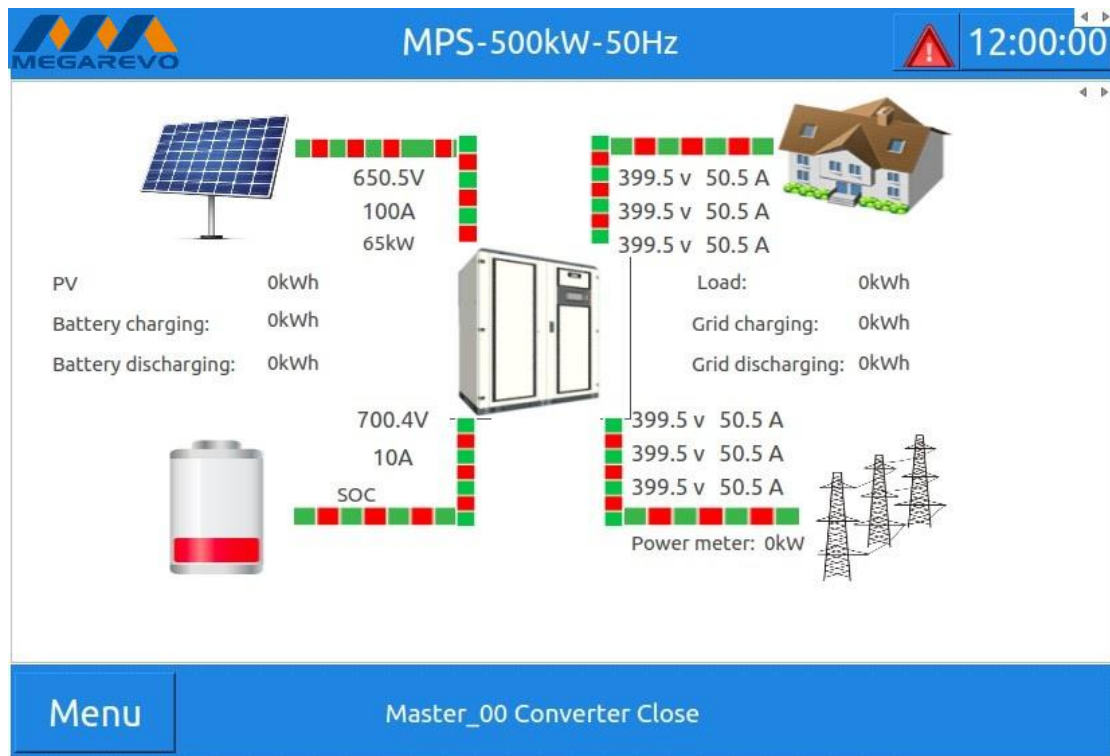

Figure 8-1 LCD Appearance

Table 8-1 Regional Function Description

Functional area	Explain
Basic Information Bar	Display company LOGO, machine model, network address, time
Function bar	Choose the menu of each function
homepage	Display current and voltage of AC and DC sides of inverter
Running status bar	Communication state, current state of inverter, alarm, state quantity

8.1.2 User Password

The MPS energy storage converter is restarted or the touch screen has not been touched for a long time (10 minutes), and then click the general setting or "system" setting button again, a password input interface will pop up, and the password is: 123.

Table 8-2 Indicator status

Indicator light	Function	State	Significance
Indicator 1	System Operating Indicator	Green always shines/fades	Abnormal monitoring system
		Green scintillation	Normal monitoring system
Indicator 2	Inverter indicator	Green is always bright	Inverter Normal work
		Green scintillation	Inverter Soft start
		Indicator turn off	Inverter does not work
Indicator 3	Alarm light	Red flashing	Inverter alarm
		Indicator turn off	Inverter no alarm

※Indicator lamp 1, indicator lamp 2, indicator lamp 3, refers to the working status indicator lamp, the order is from top to bottom.

8.2 Alarm Buzzer

Table 8-3 Buzzer Warning Mode

Whisper every 1 second	When an alarm occurs in the inverters, the alarm sounds are emitted
------------------------	---

8.3 Communication Settings

Communication parameters can set device address (modbus address) and RS485 baud rate to communicate with the host computer. The communication mode between equipment and BMS can be chosen: no communication, CAN, serial port. The communication between the equipment and the host computer supports RS485 serial communication and network communication. The settings are as follows:

RS485 Serial Communication

The Modbus address of the device ranges from 1 to 247, and each device has a unique address.

The default baud rate of serial communication is 9600 bps, 8 data bits, 1 stop bit, no parity bit.

Network communication

IP address default 192.168.1.100

Subnet mask default 255.255.255.0

Gateway default 192.168.1.1 , port 502 communication

CAN port communication

The baud rate of CAN1 port communication (internal communication) is 500kbps by default.

The baud rate of CAN2 port communication (battery BMS) can be set to 125/250/500kbps.

8.4 Main interfaces introduction

8.4.1 Homepage introduction

Taking MPS-500KW as an example, the main interface mainly displays machine model, time, battery information, inverter information, running status, and alarm information. As shown in Figure 8-2 below:

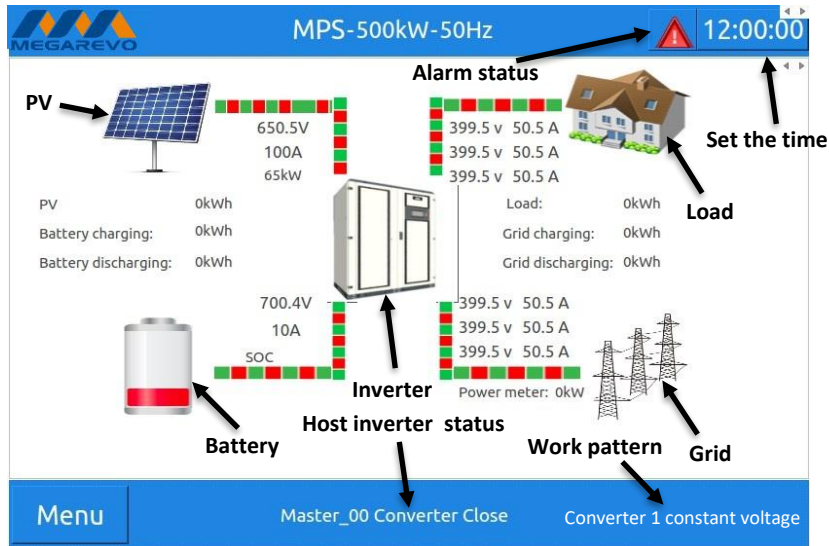

Figure 8-2 Main Interface

1. Click the "Battery" icon on the main page to view the battery properties.
2. Click the converter icon to view "real-time data".
3. Click the triangular "Warning" sign in the upper right corner of the screen to view all alarm items.



Figure 8-3 Alarm item list

The inverter display alarms are divided into AC alarm descriptions and DC alarm descriptions. At this time, the AC alarms indicate BMS communication failures, and the DC alarms indicate DC converter over current. For handling methods, refer to 9.3.3 Fault Alarms and Handling Methods.

Table 8-4 Menu expansion items

Serial number	Menu name	Menu item	Parameter function
1	homepage	Battery	When connected to a lithium battery, the battery analog quantity, status quantity and alarm quantity will be displayed; if a lead-acid battery is connected, the lead-acid battery data interface will be displayed.
		PV	PV input voltage, current
		Inverter	Display real-time data
		Load	Voltage, current, load power
		Grid	Grid input voltage, current, meter power
2	State	Data	All analog data of the inverter are displayed
		State	Display of Inverter Operation State and Switching State
		Alarm	Current system operation information and alarm
		Battery Data	Current battery real-time detection data
3	Record	Data Report	Charge and discharge statistics of PV,load,battery and grid
		Export Data	Export history record, operation record, power statistics table
		History Record	Display status records and historical fault records during operation
		Operation Log	Some important parameter modification records generated by system settings
4	Parameter Setting	DC/AC parameter setting	Grid connection mode, operation mode, constant power, etc.
		DC/DC parameter setting	Working mode, step-up/step-down, etc.
		Battery Setup	Battery parameter setting
		Auto run time setting	System automatic running time period setting
		System message	Display PCS version number
		Advanced settings	Function settings, system parameters, DCAC debugging, DCDC debugging
5	switch	Inverter switch	DCDC converter on, DCDC converter off, standby
			DCAC converter on, DCAC converter off, standby

8.4.2 Introduction to real-time data

Users can click the icons on the main interface to view the real-time data of the converter, photovoltaic terminal, load terminal, battery terminal and grid terminal; users can also click

"Menu" → "Status" to enter the status main interface. In this interface, the user can query the four data of "data", "status", "alarm" and "battery data", and the user can monitor the converter by observing the feedback data of these four real-time quantities, as shown in Figure 8 -4 shows:

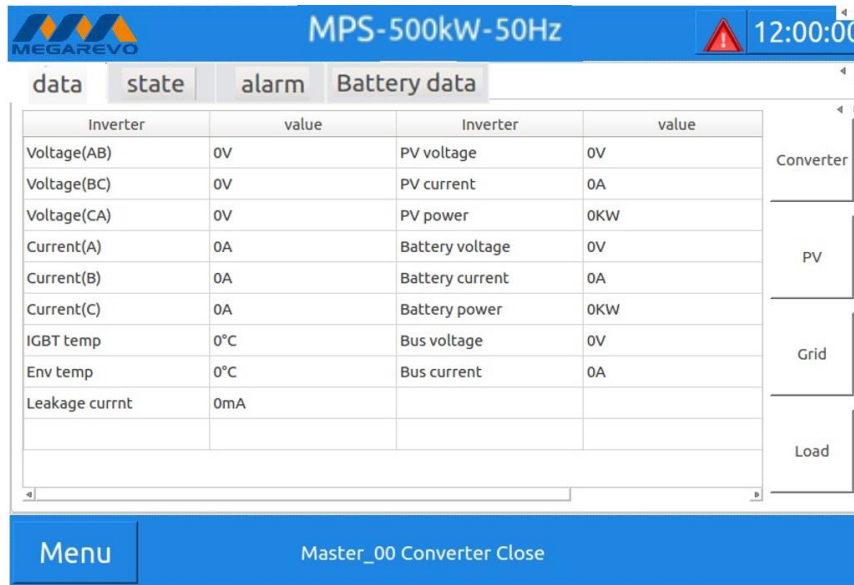

Figure 8-4 Inverter Data Interface

There are 12 buttons under the data list representing the number of DCDC modules. The number of modules that are not online will be dimmed. Users can also click on the right side or "Grid" or "Load" to query real-time monitoring data.

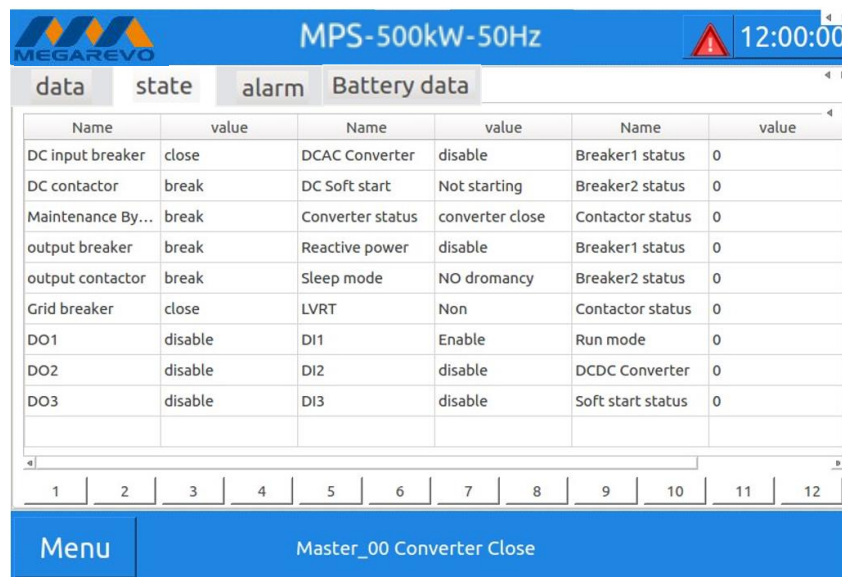

Figure 8-5 Status

Status mainly displays the operating status of various circuit breakers, contactors and converters of MPS. Its function is that users can view and understand the operating status of MPS more conveniently and intuitively. There are three columns of data in this interface, and each data has its corresponding The first two columns of data correspond to the real-time status of the DCAC module, and the third column of data corresponds to the status of the DCDC module. Clicking the number of modules will display the real-time status corresponding to the module in the first column on the right.

8.4.3 Introduction to Record Menu



Figure 8-6 Recording menu interface

The user clicks "Menu" → "Record" to enter the record menu interface, where the user can click to query "Data Report", "Export Data", "Historical Record" and "Operation Log". The function of this part is to collect the charge and discharge capacity and operation records of the MPS for easy query.

Click the "Export Data" button in the record menu, after entering this interface, you need to access the U disk, and the format of the U disk is required to be FAT32 format. You can click on the interface to export "History Record", "Operation Log" or "Data Report", and click "Exit U Disk" after the export is complete.



Figure 8-7 Export data

8.4.4 Introduction to System Settings Menu

In the menu interface, you can click "Settings" → "System", "DC/AC Parameter Setting", "DC/DC Parameter Setting", "Battery Setting", "Automatic Running Time Setting", "System Information".



DC/AC Parameter	DC/DC Parameter	Battery setup	Automatic operation	SystemInformation	Battery infor
1	2	3	4	5	6
Grid connected mode of PCS	on	-	Control mode	Local	-
Constant power (AC)	100	kw	Machine number	Master_00	-
Charging and discharging	charge	-	Parallel	Disable	-
Operational mode	System for self-use	-			
Output power factor	1	-			
Output reactive power	10				
Constant current	100	A			
Constant voltage	600	V			

Figure 8-8 DC/AC parameter setting

MPS grid-connected mode: Users can set grid-connected, off-grid or automatic here. The grid-connected mode means that the converter is connected to the grid, and can take electricity from the grid or input the photovoltaic power into the grid; the off-grid mode is not connected to the grid, and the photovoltaic power generation supplies battery charging and load; the automatic mode is the internal logic automatically switches and goes off-grid. Way. Default grid connection mode.

Constant power setting: The system defaults to AC constant power control, positive power is discharging, negative power is charging, the control accuracy is 0.1KW, and it takes effect when the control mode is CP_N&P mode.



Name	value	Unit	Name	value	Unit
Work parttern	CV	-	Battery position	HightSide	-
Boost or Buck	Buck	-	Voltage level	550	V
Bat Charging or discharging model	Charge	-	Current value	50	A
DCDC capacity	50	-			

Figure 8-9 DC/DC parameter setting

Working mode: Set the working mode of the DC-DC converter, CV is constant voltage mode,

CC is constant current mode, MPPT photovoltaic automatic tracking mode, the default is MPPT mode.

Boost/buck: When the input voltage is greater than the output voltage, it is set to buck mode; when the input voltage is less than the output voltage, it is set to boost mode (factory settings are applied according to the project).

Battery charge and discharge mode: In constant power mode, the charge and discharge settings do not take effect.

DC-DC power: The rated power of the DC-DC converter.

Battery Location: Reserved settings.

Voltage class: output voltage class.

Constant current value: The constant current value of the output side in constant current mode.

8.4.5 Battery parameter setting

"Menu"→"System"→"Battery Setting" item; the battery parameter setting interface is as shown below.

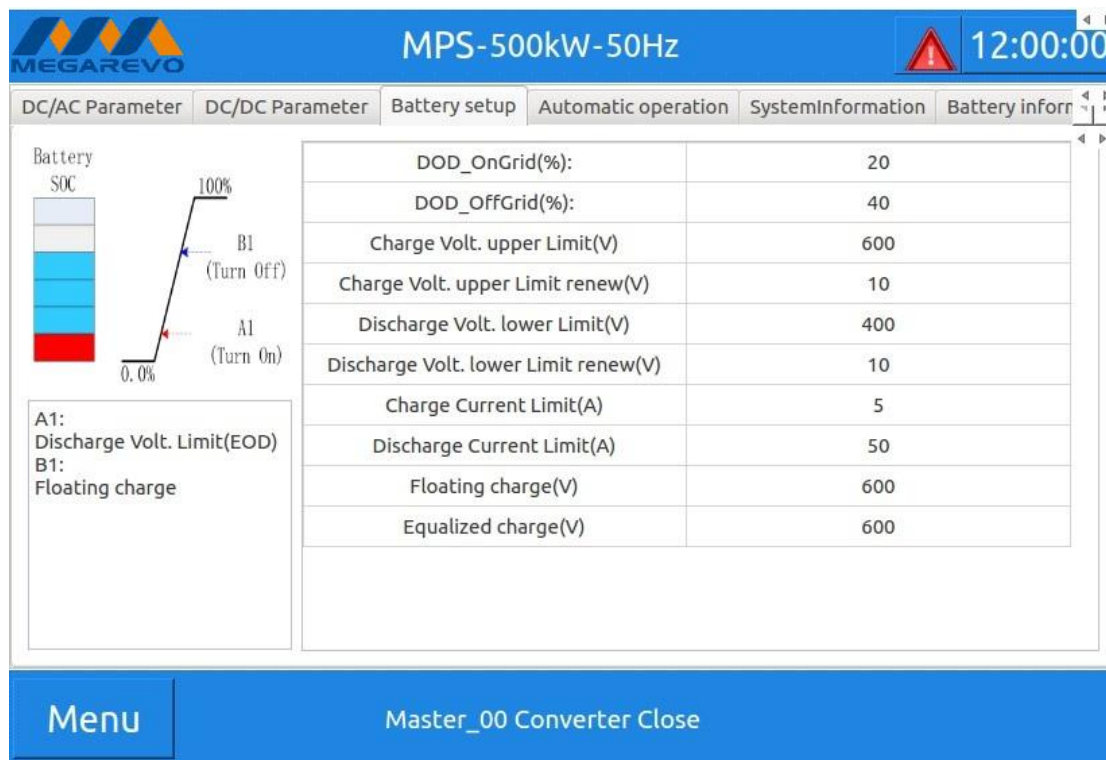

Figure 8-10 Battery parameter setting

The two parameters of grid-connected DOD and off-grid DOD do not need to be set, and these two parameters are not used in the current control; charging voltage upper limit: when off-grid, if the photovoltaic controller has sufficient energy to charge the battery, the photovoltaic will be limited after charging to the upper limit voltage. The output power of the controller is less than or equal to the load power; when the battery voltage reaches the upper limit voltage, the converter will switch to constant voltage operation.

The lower limit of the discharge voltage: the diesel generator will be turned on when the battery is discharged to the lower limit of the discharge voltage. After the diesel generator is turned on, the battery will be charged, and the charging will stop when the battery is disabled or the upper limit of the battery voltage is charged.

Charging current limit: the maximum charging current allowed to the battery.

8.4.6 Automatic running time setting

In the system menu, click "automatic running time" to enter the setting of peak-shaving and valley-filling charging and discharging time. Users can set it according to the local electricity price difference or the real peak-valley electricity consumption time.

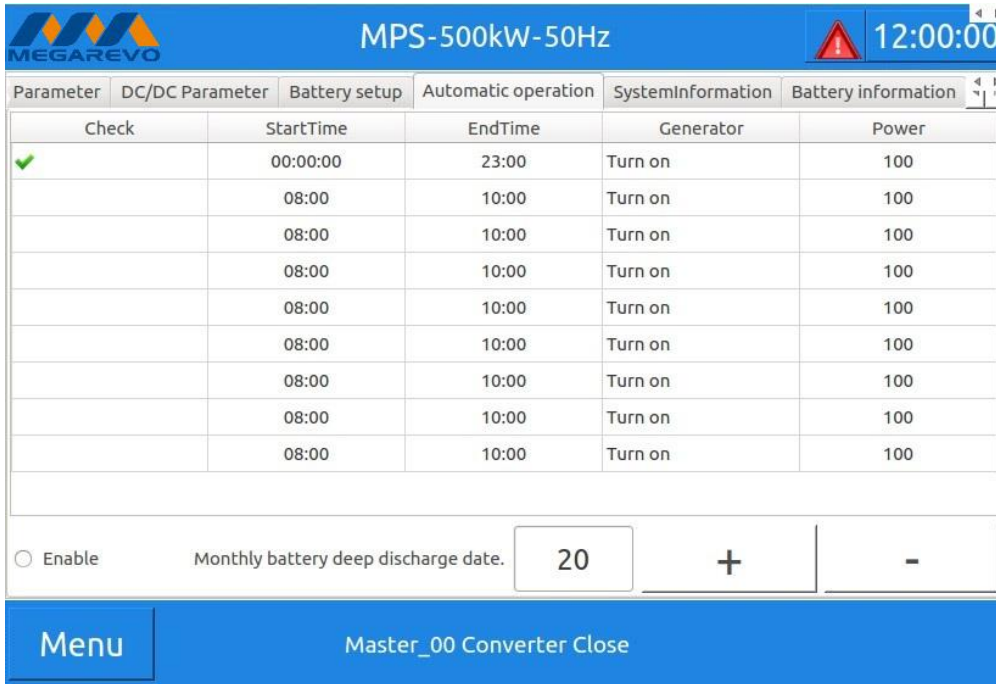

Figure 8-11 Automatic running time setting

8.4.7 System Information

The system information interface displays the protocol version and IP address settings of the MPS operating system. After the address settings are completed, click the restart button to take effect, as shown in Figure 8-12:

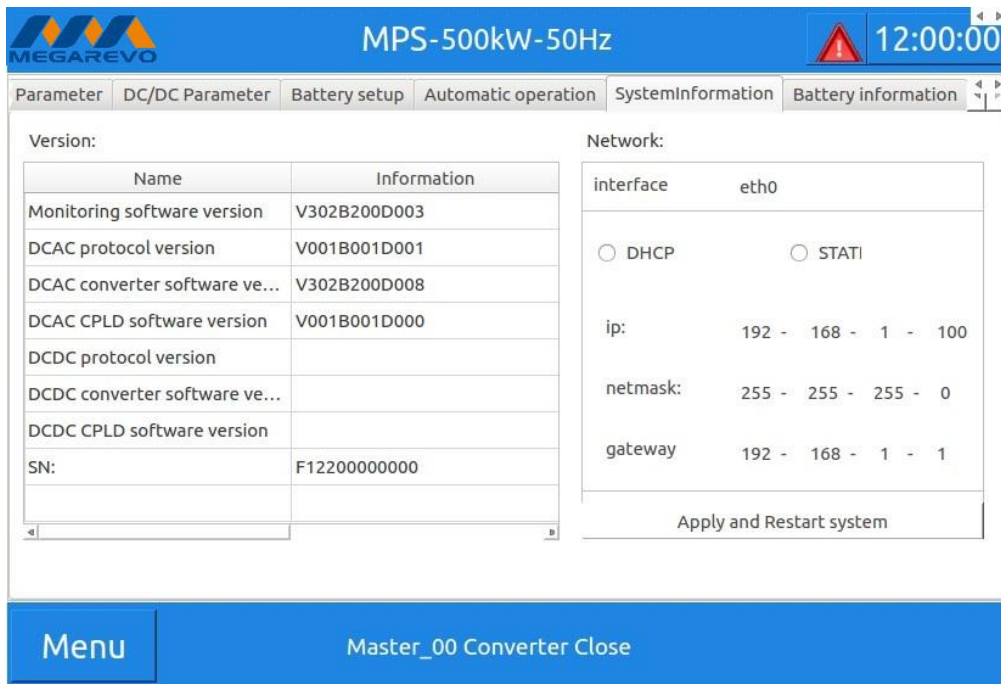
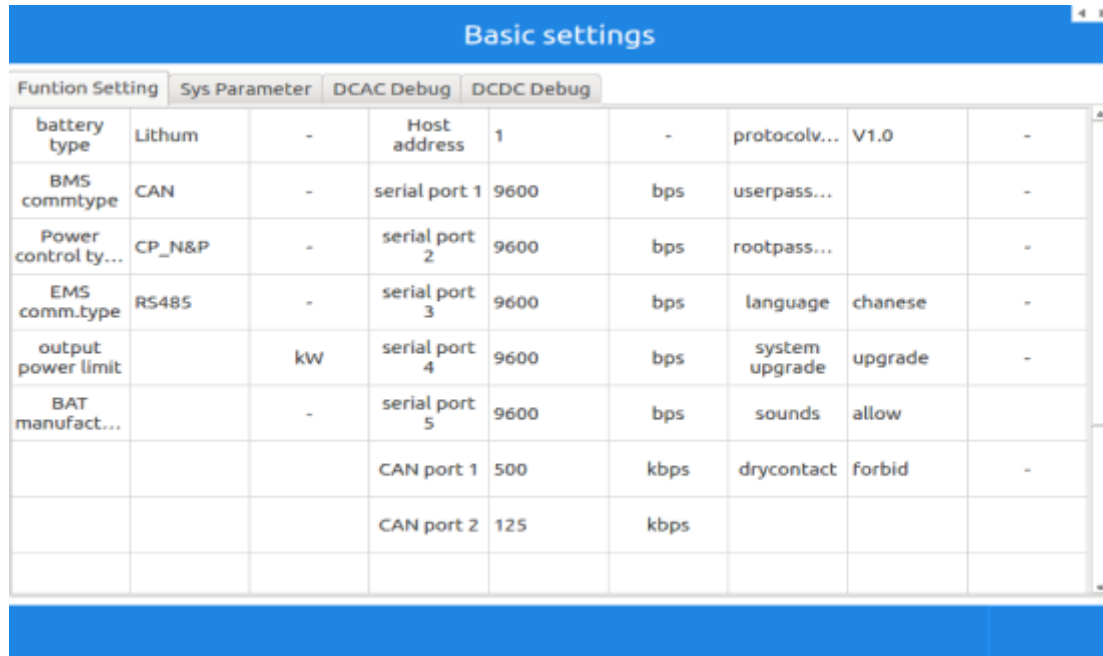

Figure 8-12 System Information

8.5 Advanced Settings

How to enter the advanced settings: "Menu" → "System" → "DCAC Parameters" → "Advanced Settings". Advanced settings are divided into four parts: function settings, system parameters, DCAC debugging, and DCDC debugging.



Basic settings								
Funtion Setting	Sys Parameter	DCAC Debug	DCDC Debug					
battery type	Lithum	-	Host address	1	-	protocolv...	V1.0	-
BMS commtype	CAN	-	serial port 1	9600	bps	userpass...		-
Power control ty...	CP_N&P	-	serial port 2	9600	bps	rootpass...		-
EMS comm.type	RS485	-	serial port 3	9600	bps	language	chanese	-
output power limit		kW	serial port 4	9600	bps	system upgrade	upgrade	-
BAT manufact...		-	serial port 5	9600	bps	sounds	allow	
			CAN port 1	500	kbps	drycontact	forbid	-
			CAN port 2	125	kbps			

Figure 8-13 Function Settings

Battery type: Choose the battery type according to the actual situation, there are two types of lithium battery and lead-acid to choose from.

Battery communication mode: Set the communication mode with the battery, you can choose RS485 or CAN communication according to the actual situation.

Power Control Type: Set the power control mode, including constant voltage, constant current, and constant power.

EMS communication mode: Set the communication mode of EMS, including RS485, CAN communication and Ethernet.

Output power upper limit: Set the maximum allowable output power.

Serial port: set the baud rate, the default is 9600. **CAN1:** The default baud rate is 500, which cannot be changed. **CAN2:** The default baud rate is 125, which can be modified according to the on-site BMS communication baud rate.

Language: Set the display language of the display screen, you can choose Chinese and English, the system will restart when the language is switched.

System upgrade: Click to enter the system upgrade application, and upgrade the system according to the upgrade document.

Dry contact: configure the dry contact function according to the project site.

8.6MPS converter program upgrade

U disk using FAT32 file system (usually U disk is in this format) (capacity \leq 32G). Put the upgrade file in the root directory of the U disk (the outermost part of the U disk and cannot be placed in the folder of the U disk).

When the system is powered on (battery system is turned on or photovoltaic and AC power input), the system is powered on, and the upgrade operation can be performed after the monitoring is running.

Press the red "EPO" button, after pressing "EPO", both the PV controller and the converter will stop working;

The user clicks "Menu" \rightarrow "System" \rightarrow "DCAC Parameters" \rightarrow "Advanced Settings" \rightarrow "Function Settings" \rightarrow "Upgrade". The upgrade interface is as follows:

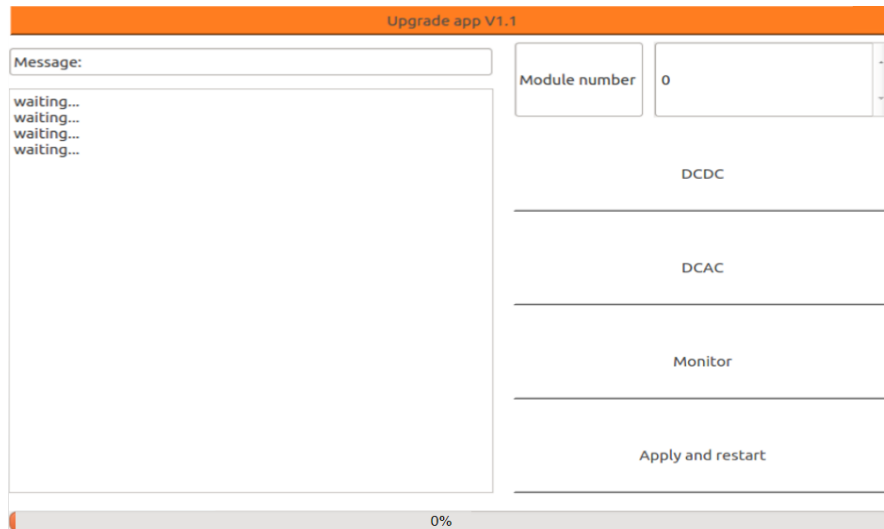

Figure 8-14 Program upgrade interface

Message: Whether the system recognizes the U disk, and "File checked ok" is displayed, the next step of the upgrade operation can be performed. If "File checked ok" is not displayed, it means that the monitoring panel does not recognize the U disk. Apply and restart" to restart the system. After the monitoring restart is complete, reinsert the U disk and re-enter the upgrade interface.

DCDC: PV controller module control program upgrade option; "Module": It only works when "DCDC" is selected, that is, the PV control module control program upgrade, "1" means to upgrade the No. 1 module, "2" means to upgrade the No. 2 module. After "File checked ok" and "DSPUpdate.hex ok" are displayed in "Message", click "DCDC" on the right to monitor the upgrade options.

DCAC: After "File checked ok" and "DSPUpdate.hex ok" are displayed in "Message", click "DCAC" on the right to update the converter control program.

Monitor: After "File checked ok" and "Monitor.hex ok" are displayed in the "information box", click "Monitor" on the right to start monitoring the software upgrade.

Apply and restart: The system restarts.

After the upgrade is completed (the progress is 100%), the monitoring will automatically restart;

⚠: **The upgrade file of PV controller and converter are both DC/DC "DSPUpdate.hex". If both PV controller and converter are to be upgraded, the upgrade file DC/AC "DSPUpdate.hex" should not be confused.**

9

Maintenance and troubleshooting

9.1 Explain

Due to the influence of ambient temperature, humidity, dust and vibration, the internal devices of energy storage inverter will be aging, which will affect the performance of inverter and can even lead to failure. Therefore, it is necessary to carry out routine and regular maintenance of energy storage inverter to ensure its normal operation and service life. All measures and methods to help the energy storage inverter in good working condition belong to the scope of maintenance work. If there is a malfunction, with the help of this manual, you still can't solve the problem. Please contact us. At the same time, provide some information in order to provide you with better service:

- ◆ Photographs of Fault Site
- ◆ Type and serial number of energy storage inverter.
- ◆ Information on components connected to energy storage inverters, configuration of energy storage batteries and network parameters.
- ◆ Communication connection scheme of energy storage inverter.
- ◆ Fault information and brief description.

9.2 Matters Needing Attention

9.2.1 General Safety Rules

In order to ensure the safety of the operators, the following five safety rules must be observed when maintaining or overhauling the energy storage inverter:

- ◆ Disconnect all external connections of the energy storage inverter and the internal power supply of the equipment.
- ◆ Ensure that the energy storage inverter is not accidentally re-energized.
- ◆ Use the multimeter to ensure that the internal of the energy storage inverter is completely dead.
- ◆ Ensure that the energy storage inverter is well grounded.
- ◆ The operating part is close to the parts that may be electrified. It needs to be covered with insulation material.



WARNING

Only qualified and authorized personnel can maintain the energy storage inverter and other operations.
In the maintenance work, do not leave screw, washer and other metal parts in the energy storage inverter to avoid damage to the inverter!



WARNING

If only the circuit breaker is disconnected, the cable connection terminals in the AC/DC cabinet of the energy storage inverter are still live!
 Before opening the cabinet door and starting the formal maintenance work, it is necessary to disconnect not only the circuit breaker, but also the front and back stage circuit breakers of the energy storage inverter.



WARNING

After the energy storage inverter is out of operation, please wait at least 15 minutes before operating it.

9.2.3 Maintenance Work And Cycle

Table 9-1 Maintenance Work Item Sheet

Maintenance project	Maintenance content	Recommendation cycle
Save record	<ul style="list-style-type: none"> ◆ Export data with USB and save backup. 	1 months
Inverter Inspection	<ul style="list-style-type: none"> ◆ Observe whether the appearance of energy storage inverter is damaged, deformed or rusted. ◆ Listen to the abnormal sound of the energy storage inverter. ◆ LCD was used to observe the running parameters. Use thermal imager and other detection systems to detect the heating status. ◆ Check whether the ventilation, ambient temperature, humidity and dust around the inverter meet the requirements. 	Half a year
Duct cleaning	<ul style="list-style-type: none"> ◆ Check duct dust. ◆ Listen to if there is any abnormal vibration when the fan is running. ◆ Use compressed air and turn on the fan for cleaning. ◆ Clean or replace the air filter 	Half a year (bad environment needs to be shortened as appropriate)
Security function	<ul style="list-style-type: none"> ◆ Check whether the EPO button is invalid ◆ Check whether the LCD closed inverter function is invalid. 	Half a year
Circuit connection	<ul style="list-style-type: none"> ◆ Check all electrical connections for looseness or poor contact. ◆ Check the surface of all cables and metal surfaces for damage or scratch. ◆ Check that the insulation bandage of all terminals is off ◆ Check screw position for signs of overheating. ◆ Check the color change of the copper bars and bolts 	1 years
Circuit Breaker Maintenance	<ul style="list-style-type: none"> ◆ Check all circuit breakers for failure. ◆ Check whether the circuit breaker or load switch is damaged. 	1 years
Identification check	<ul style="list-style-type: none"> ◆ Check device warning signs and other equipment labels. ◆ If blurred or damaged, please replace it in time 	1 years



WARNING

Due to the capacitance of DC bus, it will take at least 15 minutes to wait until the energy storage inverter is completely cut off. Before removing the dust, please use the multimeter measurement to confirm that there is no electricity in the machine, so as to avoid electric shock.

**WARNING**

The overwhelming majority of maintenance work can only be carried out by removing the protective net cover inside the machine. At the end of all maintenance work, it is necessary to restore all dismantled maintenance covers to their original state. Make sure all screws are tightened in place



Only the recommended product routine maintenance cycle is included in the table. The actual maintenance cycle should be determined according to the specific installation environment of the product. The maintenance cycle of the product will be affected by factors such as the scale of the power plant, the location of the plant and the on-site environment. It is necessary to shorten the maintenance cycle and increase the maintenance frequency if the wind and sand in the operation environment are larger or the dust is thicker.

9.2.4 Check And Replace The Air Filter

- ◆ Read the safety instructions carefully.
- ◆ Open the cabinet door.
- ◆ Check the air filter and remove it with a screwdriver if necessary.
- ◆ Check the cleanliness of cabinet. If necessary, use a soft cloth or vacuum cleaner for cleaning.
- ◆ Close the cabinet door.

9.2.5 Replacement Of Electronic Components

When replacing the electronic and electrical components in the energy storage inverter, be sure to replace the same type of components from the same manufacturer! The type of components can be obtained by identifying the energy storage inverter or the product itself. If not, please contact us.

If it is necessary to replace the products of other manufacturers or different models of the same manufacturer, it must be confirmed by our engineers. in advance. Otherwise, we will not be liable for casualties or property losses that may result from this.

9.3 Fault Handling

9.3.1 Troubleshooting

**WARNING**

Under the condition of failure, there may still be fatal high voltage inside the energy storage inverter! Only technicians who meet the requirements can perform the operations described in this chapter. "Compliance with requirements" means that operators have participated in professional training on equipment troubleshooting operations in the early stage. Please perform only the troubleshooting operations described in this manual. When operating, please observe all safety operation specifications.

When the energy storage inverter can't output as expected or the charge and discharge quantity changes abnormally, please pay attention to the following items:

- ◆ Open-circuit voltage of energy storage battery
- ◆ Whether the machine is in a state of failure
- ◆ Whether the power grid is connected correctly and powered on
- ◆ Check whether the communication of measuring equipment is normal

9.3.2 Non-Alarm Inducing Failure

Machine working noise is high

- ◆ Check whether the power is in the normal range; Measure whether the grid-connected current and voltage waveforms are normal; Check the replacement of cooling fans.

Network communication mode:

- ◆ Please check whether the IP address, subnet mask and gateway are set correctly.
- ◆ Check whether the communication line is through and whether it is well connected.
- ◆ If all the above tests are normal and correct, try to replace the LCD monitoring board.

Serial communication mode:

- ◆ Check the wiring, check all wiring is good, A/B has no connection.
- ◆ Communication adapter does not match. Replace communication adapter and try again.
- ◆ Check whether the local address and baud rate are consistent with the host computer.

LCD screen cannot be switched on and off

- ◆ Check the communication connection between LCD screen and DSP board

9.3.3 Alarm Failure List

LCD can display alarms, and the corresponding solutions are shown in Table 9-2 below.

Table 9-2 Alarm Fault Handling Method

Fault Type	Processing Method
Low battery voltage	Disconnect DC load switch and check DC side voltage and battery configuration
Battery Voltage Low Auxiliary Power Supply	Disconnect DC load switch and check DC side voltage and battery configuration
Low battery power	Disconnect DC circuit breaker load switch and check energy storage battery status
Battery Back Connection Failure	Switch-off DC-side input bus
Busbar Overvoltage Fault	Turn off to check DC side voltage
Bus Short Circuit Fault	Turn off and check DC bus connection
Overvoltage of grid	Check the voltage of grid connection point by shutdown
Low grid voltage	Check the voltage of grid connection point by shutdown
Inverse Voltage Sequence of Power Grid	Disconnect the power supply switch and Turn off to check the three-phase wiring
Abnormal Frequency of Power Grid	Turn off and check grid voltage
DC Contactor Fault	Turn off and check whether the DC contactor is damaged.

Fault Type	Processing Method
Outputcontactor open circuit	Turn off and check if AC contactor is damaged
Output Contactor Short Circuit	Turn off and check if AC contactor is damaged
AC Fan Fault	Turn off and check AC fans
AC auxiliary power failure	Turn off and check the AC auxiliary power supply board
DC auxiliary power supply failure	Turn off and check DC auxiliary power supply board
15V power failure	Turn off , check AC and DC auxiliary power supply board
Inverter overcurrent	Turn off , check whether the input and output of the inverter are short circuit or whether the inverter is overloaded.
Wave by Wave Current Limitation of Inverter	Turn off , check whether the input and output of the inverter are short circuit or whether the inverter is overloaded.
Inverter Fault	Check operation before switching off repetitive inverter
Inverter overheating	Turn off , check whether the inverter fan is out of order and whether the air duct is unobstructed.
Inverter Phase Shortage Fault	Turn off and check AC side line
Inverter asynchronization	Turn off and check the inverter settings
Lightning protection failure	Turn off and check the lightning protection of the inverter
BMS Communication Fault	Turn off and check if the communication cable between inverter and battery system is loose
Overload	Turn off and check load size
Isolated island protection	Turn off
Drive Line Fault	Turn off, Check whether the internal drive line is loose
Insulation impedance anomaly	Turn off, Check inverter grounding and cable aging
EPO	Turn off
CT or Hall Opening	Turn off, Check CT wiring

Table 9-3 DCDC Alarm Fault Handling Method

Fault Type	Processing Method
DC converter overcurrent	Shut down, troubleshoot, and turn on after the trouble is eliminated
Wave-by-wave current limiting of DC converters	Shut down, troubleshoot, and turn on after the trouble is eliminated
DC converter over temperature	Shut down, troubleshoot, and turn on after the trouble is eliminated
Output overload	Shut down, check the load size
Voltage on the high voltage side (Buck Mode Input)	Shut down, check the voltage on the high-voltage side, and turn it on after the fault is eliminated
High voltage side busbar overvoltage fault	Shut down, disconnect the input and output switches, check the voltage on the high-voltage side, and start the machine after the fault is eliminated
High voltage side busbar short circuit fault	Shut down, disconnect the input and output switches, check the voltage on the high-voltage side, and start the machine after the fault is eliminated
High-voltage side input reverse connection fault	Shut down, disconnect the input and output switches, check the voltage on the high-voltage side, and start the machine after the fault is eliminated
Low voltage side low (Boost input)	Shut down, check the low-voltage side voltage, and turn it on after the fault is eliminated
Low-voltage side busbar overvoltage fault	Shut down, disconnect the input and output switches, check the voltage on the low-voltage side, and turn it on after the fault is eliminated
Low-voltage side busbar short-circuit fault	Shut down, disconnect the input and output switches, check the voltage on the low-voltage side, and turn it on after the fault is eliminated
Low-voltage side reverse connection fault	Shut down, disconnect the input and output switches, check the voltage on the low-voltage side, and turn it on after the fault is eliminated
Drive cable fault	Shut down, check the IGBT drive cable
Lightning protection fault	Shut down, disconnect the input and output switches, and replace the lightning protection module in the cabinet

Fault Type	Processing Method
Abnormal insulation resistance	Shut down, disconnect the input and output switches
DC auxiliary power failure	Shut down, replace the auxiliary power board
DC fan failure	Shut down, check the fan air duct, power supply
Emergency shutdown	Shut down, disconnect the input and output switches, check the fault
DC converter out of sync	Shut down, disconnect the input and output switches, check the parallel network cable, and restart the DC module
High-voltage side contactor open circuit	Shut down, disconnect the input and output switches, and replace the DC contactor
High voltage side contactor short circuit	Shut down, disconnect the input and output switches, and replace the DC contactor
Low-voltage side contactor open circuit	Shut down, disconnect the input and output switches, and replace the DC contactor
Low voltage side contactor short circuit	Shut down, disconnect the input and output switches, and replace the DC contactor

9.3.4 Safety Protection Functions

Energy storage inverter has perfect protection function and warning function. When the input voltage or abnormal situation of power grid occurs, it can operate effectively to protect the safe operation of energy storage inverter and continue to operate the set mode until the abnormal situation disappears.

Table 9-4 Inverter Warning and Protection Functions

Function	Function Description
DC over/under voltage protection	When the DC voltage of the energy storage battery exceeds the allowable voltage range, the energy storage inverter will stop working and send out warning signals, and display the fault type on the LCD screen. Energy storage inverter can detect abnormal voltage quickly and react.
Overvoltage/undervoltage protection of power grid	When the energy storage inverter detects that the grid voltage exceeds the allowable voltage range, the energy storage inverter will stop working and send out warning signals, and display the fault type on the LCD screen. Energy storage inverter can detect abnormal voltage quickly and react.

Function	Function Description
Over/Under Frequency Protection of Power Grid	When the energy storage inverter detects that the frequency fluctuation of the power grid exceeds the allowable range, the energy storage inverter will stop working and send out warning signals. The fault type is displayed on the LCD screen. Energy storage inverter can detect abnormal frequency quickly and respond to it.
Isolated island protection	When the energy storage inverter detects that the grid voltage is 0, the energy storage inverter will stop working and send out warning signals, and display the fault type on the LCD screen. Energy storage inverter can detect abnormal voltage quickly and react.
AC Overcurrent Protection	When the output power of the energy storage battery exceeds the maximum DC input power allowed by the energy storage inverter, the energy storage inverter will work at the allowable maximum AC output power. When the AC current is detected to be greater than 1.2 times the rated current, the energy storage inverter will stop working. After restoring to normal, the energy storage inverter should be able to work normally.
AC leakage current protection	The energy storage inverter has the function of grounding protection. A leakage current sensor is installed in the grounding cable. When the leakage current exceeds 2A, the machine will stop immediately. When the current is less than 1.5A, the protection can be eliminated. The fault is displayed on the LCD screen.
IGBT Overtemperature Protection	IGBT module of energy storage inverter uses high precision temperature sensor, which can monitor module temperature in real time. When the temperature is too high, the DSP will issue instructions to stop the operation of energy storage inverter to protect the stable operation of equipment.
IGBT Fault Protection	The IGBT module of the energy storage inverter has self-protection function. When the module detects that the module has over-current, it can send fault information to the DSP quickly. The DSP will issue instructions to stop the energy storage inverter running, and send warning signals, and display the fault type on the LCD.
Polarity Reverse Connection Fault Protection	When the energy storage inverter detects that the DC voltage is negative, the energy storage inverter will send a warning signal and display the fault type on the liquid crystal.
Environmental Overtemperature Protection	High precision temperature sensor is used in the energy storage inverter, which can monitor the temperature inside the machine in real time. When the temperature is too high, the DSP will issue instructions to stop the operation of the energy storage inverter to protect the stable operation of the equipment.
DC Overcurrent Protection	When the energy storage inverter detects that the DC current is greater than 1.2 times the rated current, the energy storage inverter will stop working and send out warning signals, and display the fault type on the LCD. After restoring to normal, the energy storage inverter should be able to work normally.

Function	Function Description
Independent Inverter Overvoltage Protection	When the energy storage inverter operates in the independent inverting mode and detects that the three-phase output voltage exceeds the allowable voltage range, the energy storage inverter will stop working and send out warning signals, and display the fault type on the liquid crystal.
Phase Sequence Reverse Connection Protection	When the energy storage inverter self-checks and finds that the three-phase voltage phase of the connected power grid is wrong, the inverter will send out warning signals and display the fault type on the LCD. After returning to normal, the energy storage inverter should be re-energized and self-checked to work normally.
AC voltage unbalance protection	When the energy storage inverter detects that the difference of three-phase AC voltage exceeds the allowable range, the energy storage inverter will stop working and send out warning signals, and display the fault type on the LCD. Energy storage inverter can detect abnormal voltage quickly and react.
AC current unbalance protection	When the energy storage inverter detects that the difference of three-phase AC voltage exceeds the allowable range, the energy storage inverter will stop working and send out warning signals, and display the fault type on the LCD. Energy storage inverter can detect abnormal voltage quickly and react.
Transformer Overtemperature Protection	The transformer of energy storage inverter uses high precision temperature sensor, which can monitor module temperature in real time. When the temperature is too high, the DSP will issue instructions to stop the operation of energy storage inverter to protect the stable operation of equipment.
Fan Fault Protection	The fan of the energy storage inverter has the function of automatic detection. When the fan is not turned, it can send fault information to the DSP quickly. The DSP will issue instructions to stop the energy storage inverter, and send warning signals, and display the fault type on the LCD.
Fault Protection of AC/DC Contactors	When the operating state of the energy storage inverter is standby, grid-connected or off-grid, the AC/DC main contactor is detected to be disconnected, the energy storage inverter will stop working, and send out warning signals, and display the fault type on the LCD.

Appendix I: Quality Assurance

- ◆ Products that fail during quality assurance.
- ◆ We will repair or replace new products free of charge.

1. Evidence

During the warranty period, the company requires customers to produce invoices and dates for purchasing products. At the same time, the trademark on the product should be clearly visible, otherwise it has the right not to give quality assurance.

2. Conditions

- ◆ Unqualified products after replacement shall be handled by our company.
- ◆ Customers should reserve reasonable time for the company to repair faulty equipment.

3. Immunity from liability

In the following circumstances, the company has the right not to undertake quality assurance:

- ◆ The whole machine and parts have exceeded the free warranty period.
- ◆ Transportation damage.
- ◆ Improper installation, modification or use.
- ◆ Operating in very harsh environments beyond those described in this manual.
- ◆ Machine failure or damage caused by installation, repair, alteration or disassembly by non-company service personnel.
- ◆ Any installation and use beyond the scope specified in the relevant international standards.
- ◆ Machine failure or damage caused by the use of non-standard or non approved components or software.
- ◆ Damage caused by abnormal natural environment causes product failure due to the above situation. Customers require maintenance services. After judging by the company's service agencies, it can provide paid maintenance services.

 In order to continuously improve customer satisfaction, the company's products and product manuals are in the process of continuous improvement and upgrading. If there is a difference between the manuals and the products in your hand, it may be the reason for the edition, please refer to the specific products. If you still have questions, please contact us.